

Nouveautés présentées dans ce catalogue
 Neuheiten dieses Kataloges
 New products introduced in this catalogue



APPLITEC

Support de base Grundhalter Base holder			
Fabricant Hersteller Manufacturer	Machine Maschine Machine	Type Typ Type	Page Seite Page
Citizen	L12	ML12	11.07-11.15
	R04		
	R07		
	L20E	ML16	
Metafil	D10	ML12	11.19
Star	SB12RG	ML12	11.20-11.32
	SW12RII		
	SR20RIV	ML16	
	SR32J		
	SW20R		
Tornos	SWISS-NANO 7	ML12	11.37-11.44
	DT13		
	CT20		
	GT13		
	DT26	ML16	
	GT26		
	GT32		
Tsugami	B074	ML12	11.51
	B075		11.52
	P034		11.53-11.54

Porte-outils Halter Holders			
TOP-Line	> 11.60	TOP-Line	> 11.71
TURN-Line	> 11.61		
ISO-Line	> 11.62		
EVOCUT-Line	> 11.64	EVOCUT-Line	> 11.74
CUT-Line	> 11.65		
PRO-Line	> 11.66		
ECO-Line	> 11.66		

Système d'outils modulaires

Modulares Werkzeugsystem

Modular tooling system

Original system



MODU-Line system



Système d'outils modulaires
pour tours automatiques

Modulares Werkzeugsystem
für Langdrehautomaten

Modular tooling system for
sliding headstock automatic lathes

Les avantages

Die Vorteile

The advantages

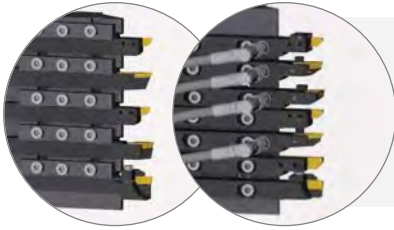

Plus d'outils disponibles
Höhere Werkzeuganzahl
More available tools

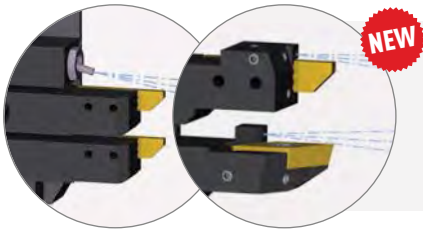

Système d'arrosage efficace
Effizientes Kühlmittelzufuhrsystem
Efficient coolant supply system

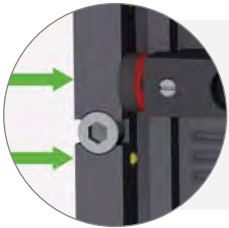

Repositionnement précis, poussée axiale automatique
Präzise Nachpositionierung, automatischer Axialschub
Precise repositioning, automatic axial thrust



Possibilité de pré réglage et de réglage de la longueur des outils
Voreinstellbar auf feste oder einstellbare Länge
Presetting on fixed or adjustable length

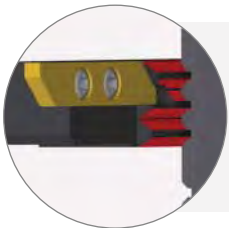

Système de fixation robuste et rigide
Robustes und starres Spannsystem
Strong and stable clamping system



Changement d'outil simple et rapide
Einfacher und schneller Werkzeugwechsel
Easy and quick tool replacement

Adaptations disponibles pour les machines suivantes:
 Verfügbare Anpassungen für folgende Maschinen:
 Available adapters for the following machines:

**Citizen - Hanwha -
 Manurhin - Metafil - > 11.06
 Star - Tornos - Tsugami**

Porte-outils
 Halter
 Holders

INFO > 11.56

ML12



ML16



Right cut

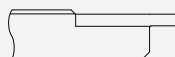

Cut off line



TOP-Line	11.60	TOP-Line	11.70
TURN-Line	11.61	TURN-Line	11.72
ISO-Line	11.62	ISO-Line	11.73
EVOCUT-Line	11.64	EVOCUT-Line	11.74
CUT-Line	11.65	CUT-Line	11.75
PRO-Line	11.66	PRO-Line	11.76
ECO-Line	11.66	ECO-Line	11.77
IN-Line	11.67		
TOOLING-Line	11.69		

Modules d'arrosage et de serrage
 Kühlmittelzufuhr- und Spannelemente
 Coolant and clamping supply unit



> 11.78

Banc de pré réglage
 Voreinstellgerät
 Presetting device



> 11.80

Pièces de rechange
 Ersatzteile
 Spare parts



> 11.82

Adaptations disponibles pour les machines suivantes

Verfügbare Anpassungen für folgende Maschinen

Available adapters for the following machines

Fabricant Hersteller Manufacturer	Machine Maschine Machine	Adaptations Anpassungen Adapters	Type Typ Type	Page Seite Page
Citizen	C12/C16	ML12-CITIZEN-C16	ML12	11.06
	L12	ML12-CITIZEN-L12		11.07
	R04	ML12-CITIZEN-R04-QTF3101-3T		11.10
		ML12-CITIZEN-R04-QTF5008-4T		11.08
		ML12-CITIZEN-R04-QTF5108-4T		
	R07	ML12-CITIZEN-R07-QTF4008-5T		11.11
		ML12-CITIZEN-R07-QTF4108-6T		
		ML12-CITIZEN-R07-QTF4208-3T		
		ML12-CITIZEN-R07-QTF4608-4T		
	K16	ML16-CITIZEN-K16	ML16	11.13
L20	ML16-CITIZEN-L20	11.14		
L20E	ML16-CITIZEN-L20E	11.15		
Hanwha	XD20M	ML12-HANWHA-XD20M	ML12	11.16
	SL12/16	ML16-HANWHA-SL12/16	ML16	11.17
Manuhrin	KMX 426/526/626	ML16-KMX26-DUO	ML16	11.18
		ML16-KMX26-JET		
Metafil	D10	ML12-D10-3T	ML12	11.19
Star	SB12RG	ML12-STAR-SB-12RG	ML12	11.20
	SR10-J	ML12-STAR-SR-10J		11.21
	SW12RII	ML12-STAR-SW-12RII-2T		11.22
		ML12-STAR-SW-12RII-8T		
	SA-12/SA16/SA16R	ML16-STAR-SA-16	11.23	
	SB16	ML16-STAR-SB-16	11.24	
	SB16/20RG	ML16-STAR-SB-16/20RG	11.25	
	SB20C/E	ML16-STAR-SB-20	11.26	
	SR20J	ML16-STAR-SR-20J	11.28	
	SR-16R/SR20R/SR20RII	ML16-STAR-SR-20R	11.27	
	SR20RIII	ML16-STAR-SR-20RIII	ML16	11.28
	SR20RIV	ML16-STAR-SR-20RIV-2T		11.29
		ML16-STAR-SR-20RIV-6T		
	SR32J	ML16-STAR-SR-32J	11.30	
	SV12/20	ML16-STAR-SV-12/20	11.31	
SW20R	ML16-STAR-SW-20R-2T	11.32		
	ML16-STAR-SW-20R-6T			
Tornos	DECO7/10 - EvoDECO 10	ML12-DECO10-DUO	ML12	11.33
		ML12-DECO10-JET		
	SWISS-NANO /SWISS-NANO 7	ML12-SWISS-NANO-2T		11.36
		ML12-SWISS-NANO-3T		
		ML12-SWISS-NANO-6T		

Adaptations disponibles pour les machines suivantes
Verfügbare Anpassungen für folgende Maschinen
Available adapters for the following machines

Fabricant Hersteller Manufacturer	Machine Maschine Machine	Adaptations Anpassungen Adapters	Type Typ Type	Page Seite Page
Tornos	SWISS-NANO 7	ML12-SWISS-NANO-4T	ML12	11.37
	DT13	ML12-DT13-2020206-9T		11.38
	CT20	ML12-CT20-2020019-7T		11.39
	GT13	ML12-GT13-390224-5T		11.40
		ML12-GT13-390223-7T		
	DEC013- EvoDEC016	ML16-DEC013-DUO	ML16	11.46
		ML16-DEC013-JET		
	DEC020/26 - EvoDEC020/32	ML16-DEC020-DUO		11.47
		ML16-DEC020-JET		
	SIGMA20/32	ML16-S20-DUO	11.48	
		ML16-S20-JET		
	ST26	ML16-SWISS-ST26-DUO	ML16	11.49
		ML16-SWISS-ST26-JET		
	DT26	ML16-DT26-2020206-7T	11.50	
ML16-GT26-386210-5T				
GT26	ML16-GT26-386209-6T	11.42		
	ML16-GT32-389210-4T			
GT32	ML16-GT32-389209-5T	11.44		
Tsugami	B074	ML12-B074-1-6T	ML12	11.51
	B075	ML12-B075-1-8T		11.52
	P034	ML12-P034-1-5T		11.53
		ML12-P034-1-7T		11.54
		ML12-P034-2-4T		11.53
		ML12-P034-2-10T		11.54

Citizen C12 / C16

+ 2 outils (max 8)
 + 2 Werkzeuge (max 8)
 + 2 tools (max 8)

ML12

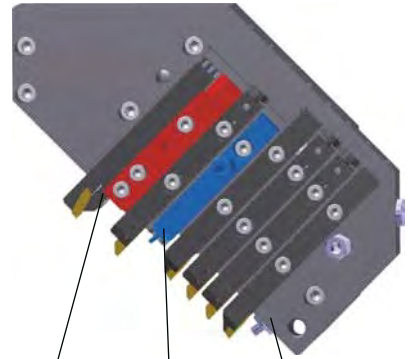
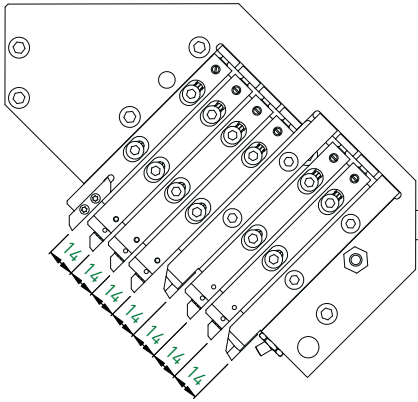

Outil \square 12 mm possible avec module de serrage
 Werkzeug \square 12 mm mit Spannelement möglich
 Tool \square 12mm possible with clamping unit

Module d'arrosage (prend la place d'un outil)
 Kühlmittelzufuhrelement (nimmt den Platz eines Werkzeuges)
 Coolant supply unit (takes the place of one tool)

Arrosage intégré
 Integrierter Kühlmittel
 Integrated coolant

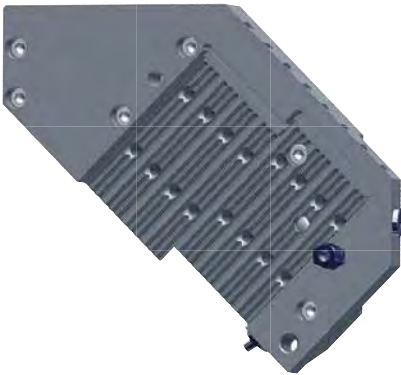

Support de base Grundhalter Base holder		Citizen C12 / C16		Accessoires Zubehöre Accessories	
Art. N°	Porte-outils Halter Holders	Pages Seiten Pages	Module de serrage Spannelement Clamping unit	Module d'arrosage Kühlmittelzufuhrelement Coolant supply unit	Page Seite Page
ML12-CITIZEN-C16	ML12	> 11.60	ML12-FIX-12/14	ML12-JET-5/16	11.78

Citizen L12

- + 2 outils (max 8)
- + 2 Werkzeuge (max 8)
- + 2 tools (max 8)

ML12

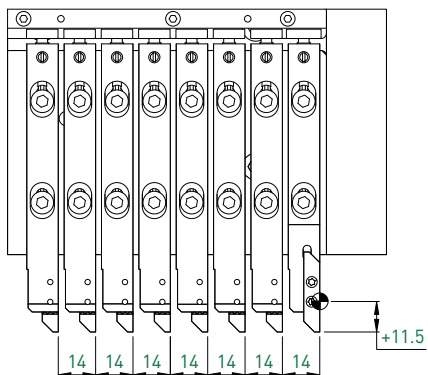

Support de base Grundhalter Base holder		Citizen L12		Accessoires Zubehöre Accessories	
Art. N°	Porte-outils Halter Holders	Pages Seiten Pages	Module de serrage Spannelement Clamping unit	Module d'arrosage Kühlmittelzufuhrelement Coolant supply unit	Page Seite Page
ML12-CITIZEN-L12	ML12	> 11.60	-	ML12-JET-5/16	11.78

Citizen R04

- + 1 outil (max 8)
- + 1 Werkzeug (max 8)
- + 1 tool (max 8)

ML12

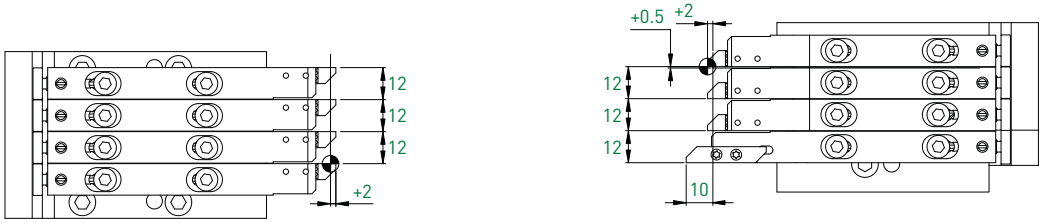

ML12-CITIZEN-R04-QTF5008-4T

ML12-CITIZEN-R04-QTF5108-4T

Support de base Grundhalter Base holder		Citizen R04		Accessoires Zubehöre Accessories		
Type Typ Type	Art. N°	Porte-outils Halter Holders	Pages Seiten Pages	Module de serrage Spannelement Clamping unit	Module d'arrosage Kühlmittelzufuhrelement Coolant supply unit	Page Seite Page
4T	ML12-CITIZEN-R04-QTF5008-4T ML12-CITIZEN-R04-QTF5108-4T	ML12	> 11.60	-	ML12-JET-5/16	11.78

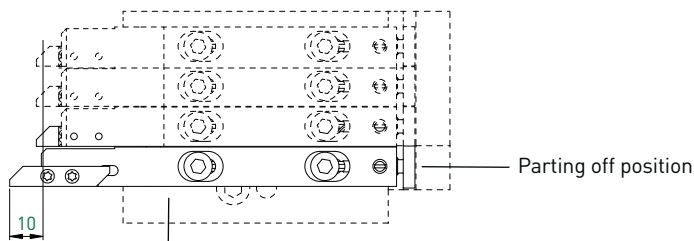

ML12-CITIZEN-R04-QTF5108-4T

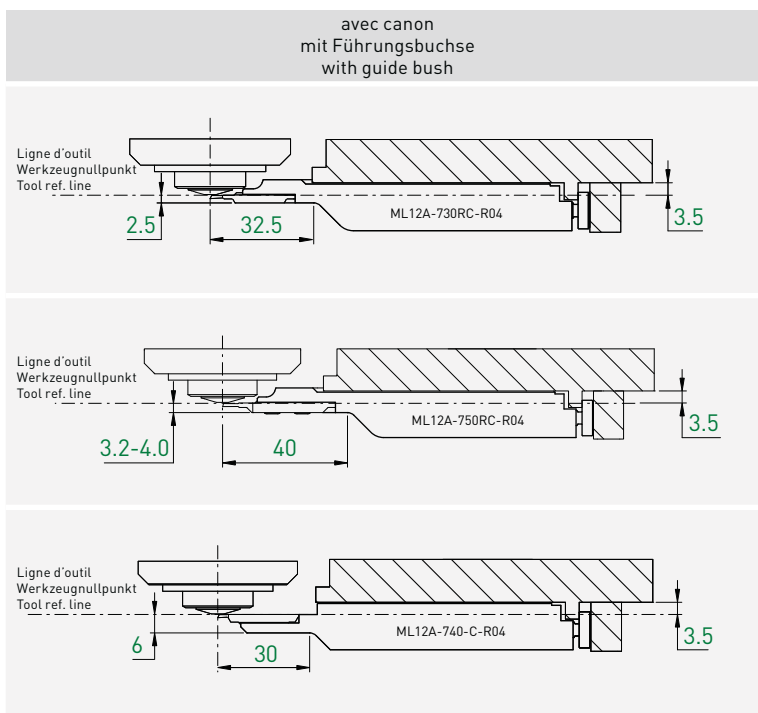

Type de machine Maschinen-Typ Type of machine	Porte-outils Halter Holders	Art. N°	Plaquettes Wendepplatten Inserts	Pages Seiten Pages
Citizen R04	ML12	ML12A-730RC-R04	731R... / 731RSF	1.39-45 / 2.20
		ML12A-750RC-R04	751R... / 751RDSF	1.88-97 / 2.20
		ML12A-740-C-R04	741 / 741SF	1.32-38 / 2.12

Citizen R04

- + 3 outils (max 3)
- + 3 Werkzeuge (max 3)
- + 3 tools (max 3)

ML12

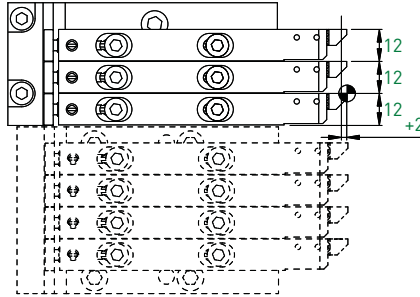

Support de base Grundhalter Base holder		Citizen R04		Accessoires Zubehöre Accessories	
Art. N°	Porte-outils Halter Holders	Pages Seiten Pages	Module de serrage Spannelement Clamping unit	Module d'arrosage Kühlmittelzufuhrelement Coolant supply unit	Page Seite Page
ML12-CITIZEN-R04-QTF3101-3T	ML12	> 11.60	-	ML12-JET-5/16	11.78

Citizen R07

- + 1 outil (max 11)
- + 1 Werkzeug (max 11)
- + 1 tool (max 11)

ML12

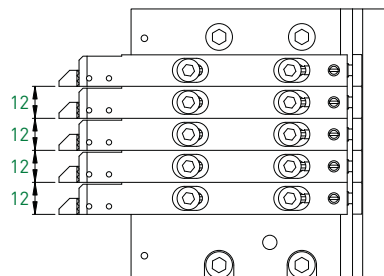
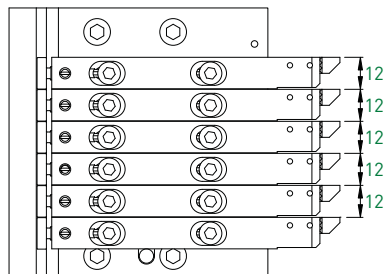

ML12-CITIZEN-R07-QTF4108-6T

ML12-CITIZEN-R07-QTF4008-5T

Support de base Grundhalter Base holder		Citizen R07		Accessoires Zubehöre Accessories		
Type Typ Type	Art. N°	Porte-outils Halter Holders	Pages Seiten Pages	Module de serrage Spannelement Clamping unit	Module d'arrosage Kühlmitelzufuhrelement Coolant supply unit	Page Seite Page
5T	ML12-CITIZEN-R07-QTF4008-5T	ML12	> 11.60	-	ML12-JET-5/16	11.78
6T	ML12-CITIZEN-R07-QTF4108-6T					

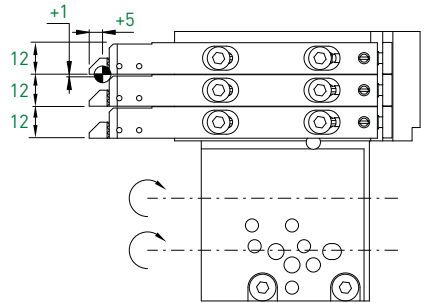
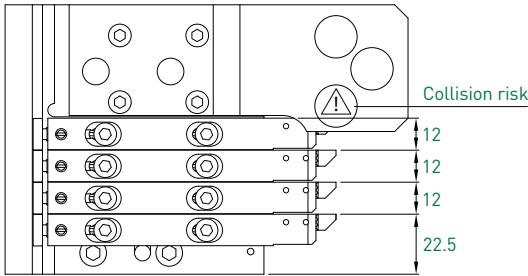

ML12-CITIZEN-R07-QTF4608-4T

ML12-CITIZEN-R07-QTF4208-3T

Support de base Grundhalter Base holder		Citizen R07		Accessoires Zubehöre Accessories		
Type Typ Type	Art. N°	Porte-outils Halter Holders	Pages Seiten Pages	Module de serrage Spannelement Clamping unit	Module d'arrosage Kühlmittelzufuhrelement Coolant supply unit	Page Seite Page
3T	ML12-CITIZEN-R07-QTF4208-3T	ML12	> 11.60	-	ML12-JET-5/16	11.78
4T	ML12-CITIZEN-R07-QTF4608-4T					

Citizen K12 / K16

- + 2 outils (max 8)
- + 2 Werkzeuge (max 8)
- + 2 tools (max 8)

ML16

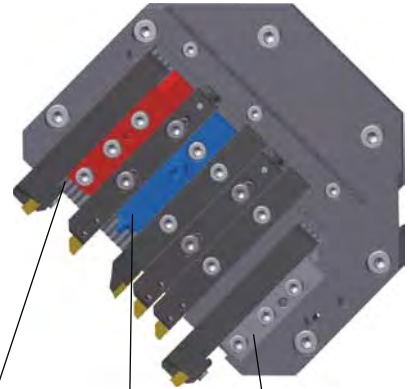
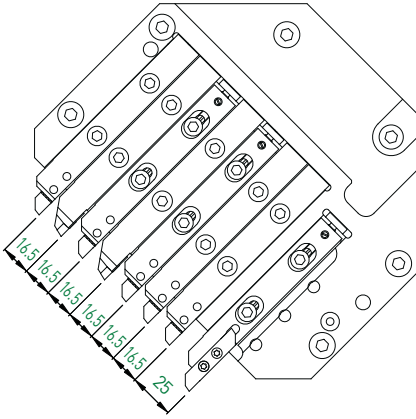

Outil \square 16 mm possible avec module de serrage
 Werkzeug \square 16 mm mit Spannelement möglich
 Tool \square 16 mm possible with clamping unit

Module d'arrosage (prend la place d'un outil)
 Kühlmittelzufuhrelement (nimmt den Platz eines Werkzeuges)
 Coolant supply unit (takes the place of one tool)

1 serrage ML16-FIX-16 pour outil \square 16 mm inclus
 1 Spannung ML16-FIX-16 für Werkzeug \square 16 mm inbegriffen
 1 clamping ML16-FIX-16 for tool \square 16 mm included

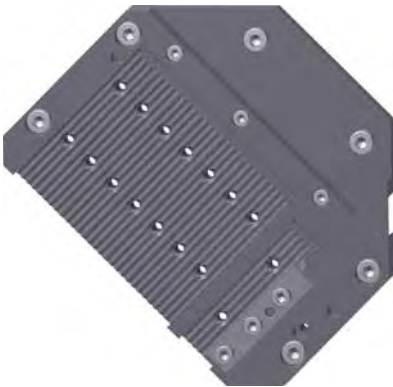

Support de base Grundhalter Base holder		Citizen K12 / K16		Accessoires Zubehöre Accessories	
Art. N°	Porte-outils Halter Holders	Pages Seiten Pages	Module de serrage Spannelement Clamping unit	Module d'arrosage Kühlmittelzufuhrelement Coolant supply unit	Page Seite Page
ML16-CITIZEN-K16	ML16	> 11.60	ML16-FIX-16/16.5	ML16-JET-7/16	11.78

Citizen L16 / L20

- + 1 outil (max 7)
- + 1 Werkzeug (max 7)
- + 1 tool (max 7)

ML16

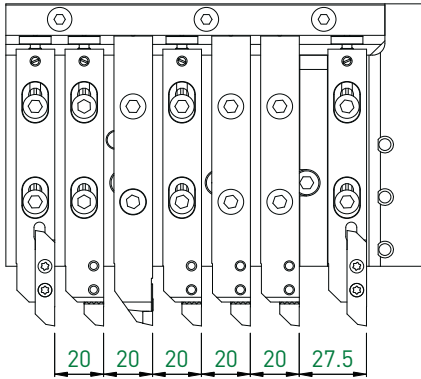

Module d'arrosage (prend la place d'un outil)
 Kühlmittelzufuhrelement (nimmt den Platz eines Werkzeuges)
 Coolant supply unit (takes the place of one tool)

- 1 serrage ML16-FIX-16 pour outil \varnothing 16 mm inclus
- 1 Spannung ML16-FIX-16 für Werkzeug \varnothing 16 mm inbegriffen
- 1 clamping ML16-FIX-16 for tool \varnothing 16 mm included



Support de base Grundhalter Base holder		Citizen L16 / L20		Accessoires Zubehöre Accessories	
Art. N°	Porte-outils Halter Holders	Pages Seiten Pages	Module de serrage Spannelement Clamping unit	Module d'arrosage Kühlmittelzufuhrelement Coolant supply unit	Page Seite Page
ML16-CITIZEN-L20	ML16	> 11.60	-	ML16-JET-7/16	11.78

Citizen L20E

- + 1 outil (max 6)
- + 1 Werkzeug (max 6)
- + 1 tool (max 6)

ML16

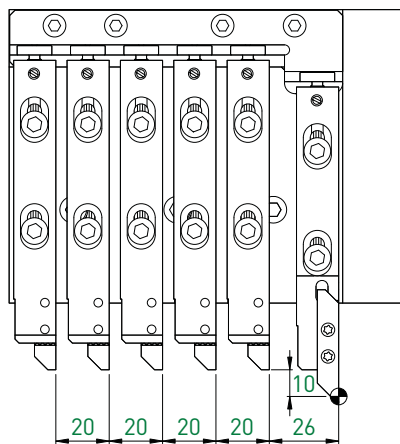

Support de base Grundhalter Base holder		Citizen L20E		Accessoires Zubehöre Accessories		
Art. N°	Porte-outils Halter Holders	Pages Seiten Pages	Module de serrage Spannelement Clamping unit	Module d'arrosage Kühlmittelzufuhrelement Coolant supply unit	Page Seite Page	
ML16-CITIZEN-L20E	ML16	> 11.60	-	ML16-JET-7/16	11.78	

Hanwha XD20M

- + 2 outils (max 7)
- + 2 Werkzeuge (max 7)
- + 2 tools (max 7)

ML12

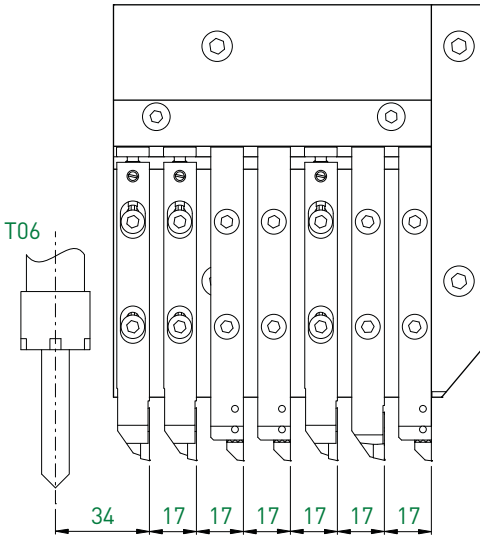

Support de base Grundhalter Base holder		Hanwha XD20M		Accessoires Zubehöre Accessories	
Art. N°	Porte-outils Halter Holders	Pages Seiten Pages	Module de serrage Spannelement Clamping unit	Module d'arrosage Kühlmittelzufuhrelement Coolant supply unit	Page Seite Page
ML12-HANWHA-XD20M	ML12	> 11.60	-	ML12-JET-5/16	11.78

Hanwha SL12 / 16

- + 1 outil (max 7)
- + 1 Werkzeug (max 7)
- + 1 tool (max 7)

ML16

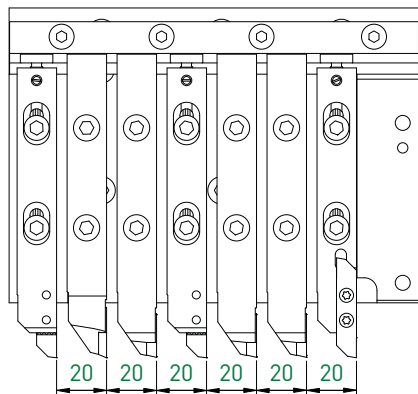

Support de base Grundhalter Base holder		Hanwha SL12 / 16		Accessoires Zubehöre Accessories	
Art. N°	Porte-outils Halter Holders	Pages Seiten Pages	Module de serrage Spannelement Clamping unit	Module d'arrosage Kühlmittelzufuhrelement Coolant supply unit	Page Seite Page
ML16-HANWHA-SL12/16	ML16	> 11.60	-	ML16-JET-7/16	11.78

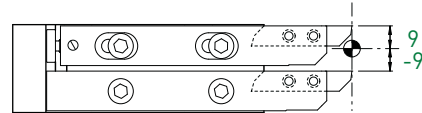
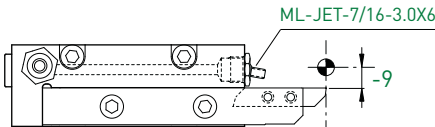

Jet



Duo

Support de base Grundhalter Base holder		Manurhin KMX 426/526/626 Swing 20-26 mm		Accessoires Zubehöre Accessories		
Type Typ Type	Art. N°	Porte-outils Halter Holders	Pages Seiten Pages	Module de serrage Spannelement Clamping unit	Module d'arrosage Kühlmittelezufuhrelement Coolant supply unit	Page Seite Page
Jet	ML16-KMX26-JET	ML16	> 11.60	-	ML-JET-7/16...	11.78
Duo	ML16-KMX26-DUO			-	ML16-JET-7/16	

D3	+ 1 outil (max 3)	ML12
Metafil D10	+ 1 Werkzeug (max 3)	
D13	+ 1 tool (max 3)	

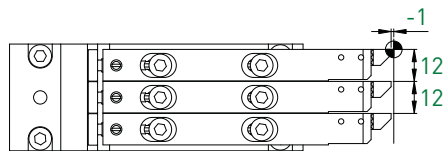

Support de base Grundhalter Base holder		Metafil D3 / D10 / D13		Accessoires Zubehöre Accessories	
Art. N°	Porte-outils Halter Holders	Pages Seiten Pages	Module de serrage Spannelement Clamping unit	Module d'arrosage Kühlmittelzufuhrelement Coolant supply unit	Page Seite Page
ML12-D10-3T	ML12	> 11.60	-	ML12-JET-5/16	11.78

Star SB-12RG

- + 2 outils (max 9)
- + 2 Werkzeuge (max 9)
- + 2 tools (max 9)

ML12

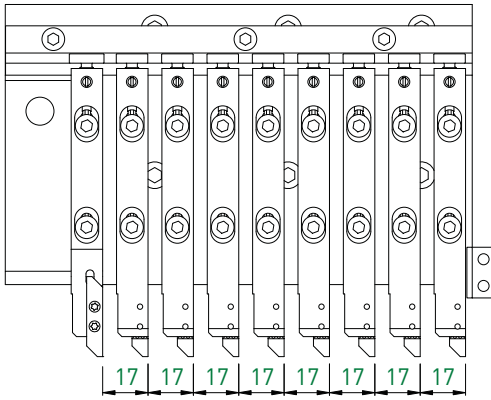

Support de base Grundhalter Base holder		Star SB-12RG		Accessoires Zubehöre Accessories	
Art. N°	Porte-outils Halter Holders	Pages Seiten Pages	Module de serrage Spannelement Clamping unit	Module d'arrosage Kühlmittelzufuhrelement Coolant supply unit	Page Seite Page
ML12-STAR-SB-12RG	ML12	> 11.60	-	ML12-JET-5/16	11.78

Star SR-10J

- + 2 outils (max 8)
- + 2 Werkzeuge (max 8)
- + 2 tools (max 8)

ML12

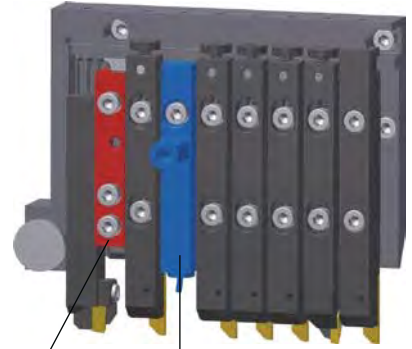
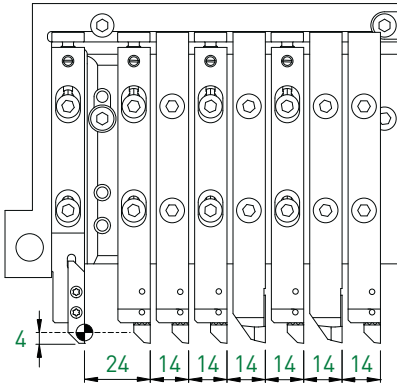

- 1 serrage ML12-FIX-12 pour outil \square 12 mm inclus
- 1 Spannung ML12-FIX-12 für Werkzeug \square 12 mm inbegriffen
- 1 clamping ML12-FIX-12 for tool \square 12 mm included

Module d'arrosage (prend la place d'un outil)
 Kühlmittelzufuhrelement (nimmt den Platz eines Werkzeuges)
 Coolant supply unit (takes the place of one tool)



Support de base Grundhalter Base holder		Accessoires Zubehöre Accessories			
Star SR-10J					
Art. N°	Porte-outils Halter Holders	Pages Seiten Pages	Module de serrage Spannelement Clamping unit	Module d'arrosage Kühlmittelzufuhrelement Coolant supply unit	Page Seite Page
ML12-STAR-SR-10J	ML12	> 11.60	ML12-FIX-12/14	ML12-JET-5/16	11.78

Star SW-12RII

+ 2 outils (max 10)
 + 2 Werkzeuge (max 10)
 + 2 tools (max 10)

ML12

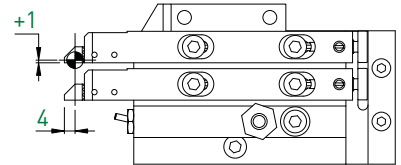
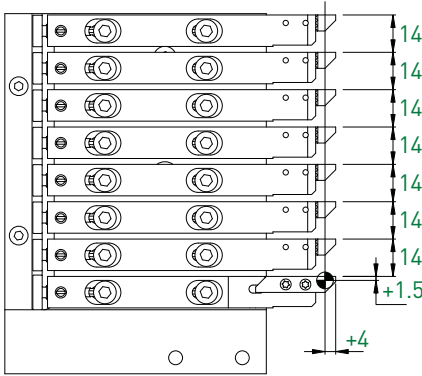

Position uniquement utilisable avec module d'arrosage, en option
 Position nur mit Kühlmittelzufuhrelement verwendbar, optional
 Position only with coolant supply unit usable, optional



ML12-STAR-SW-12RII-8T

ML12-STAR-SW-12RII-2T

Support de base Grundhalter Base holder		Star SW-12RII		Accessoires Zubehöre Accessories		
Type Typ Type	Art. N°	Porte-outils Halter Holders	Pages Seiten Pages	Module de serrage Spannelement Clamping unit	Module d'arrosage Kühlmittelzufuhrelement Coolant supply unit	Page Seite Page
2T	ML12-STAR-SW-12RII-2T	ML12	> 11.60	-	ML12-JET-5/16	11.78
8T	ML12-STAR-SW-12RII-8T					

- SA-12 + 2 outils (max 8)
- Star SA-16 + 2 Werkzeuge (max 8)
- SA-16R + 2 tools (max 8)

ML16

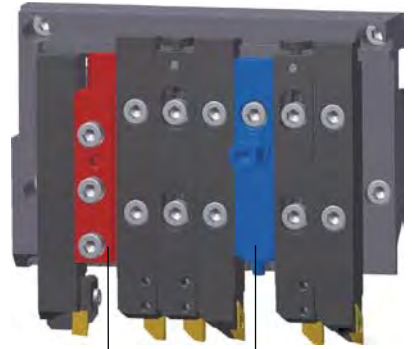
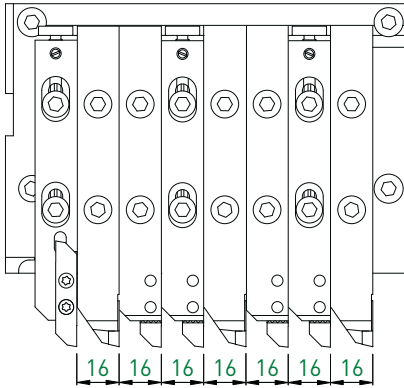

Outil \square 16 mm possible avec module de serrage
 Werkzeug \square 16 mm mit Spannelement möglich
 Tool \square 16 mm possible with clamping unit

Module d'arrosage (prend la place d'un outil)
 Kühlmittelzufuhrelement (nimmt den Platz eines Werkzeuges)
 Coolant supply unit (takes the place of one tool)



Support de base Grundhalter Base holder		Star SA-12/SA-16/SA-16R		Accessoires Zubehöre Accessories	
Art. N°	Porte-outils Halter Holders	Pages Seiten Pages	Module de serrage Spannelement Clamping unit	Module d'arrosage Kühlmittelzufuhrelement Coolant supply unit	Page Seite Page
ML16-STAR-SA-16	ML16	> 11.60	ML16-FIX-16/16	ML16-JET-7/16	11.78

Star SB-16

+ 3 outils (max 8)
 + 3 Werkzeuge (max 8)
 + 3 tools (max 8)

ML16

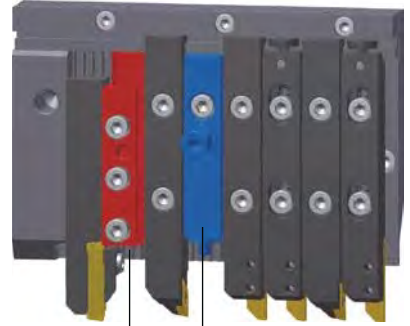
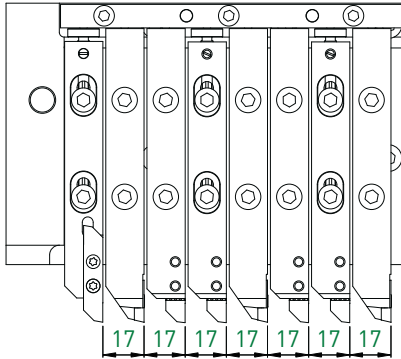

Outil \square 16 mm possible avec module de serrage
 Werkzeug \square 16 mm mit Spannelement möglich
 Tool \square 16 mm possible with clamping unit

Module d'arrosage (prend la place d'un outil)
 Kühlmittelzufuhrelement (nimmt den Platz eines Werkzeuges)
 Coolant supply unit (takes the place of one tool)



Support de base Grundhalter Base holder		Star SB-16		Accessoires Zubehöre Accessories	
Art. N°	Porte-outils Halter Holders	Pages Seiten Pages	Module de serrage Spannelement Clamping unit	Module d'arrosage Kühlmittelzufuhrelement Coolant supply unit	Page Seite Page
ML16-STAR-SB-16	ML16	> 11.60	ML16-FIX-16/17	ML16-JET-7/16	11.78

Star SB-16/20RG

- + 1 outil (max 7)
- + 1 Werkzeug (max 7)
- + 1 tool (max 7)

ML16

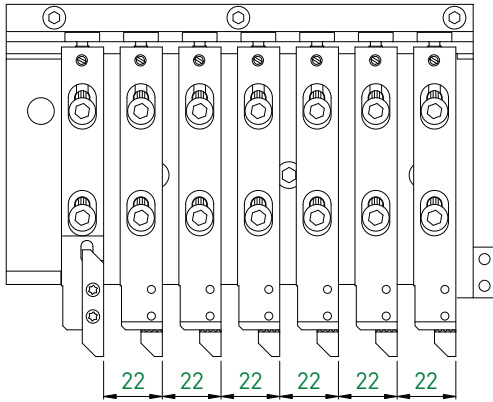

Outil \square 16 mm possible avec module de serrage
 Werkzeug \square 16 mm mit Spannelement möglich
 Tool \square 16 mm possible with clamping unit

Module d'arrosage (prend la place d'un outil)
 Kühlmittelzufuhrelement (nimmt den Platz eines Werkzeuges)
 Coolant supply unit (takes the place of one tool)



Support de base Grundhalter Base holder		Star SB-16/20RG		Accessoires Zubehöre Accessories	
Art. N°	Porte-outils Halter Holders	Pages Seiten Pages	Module de serrage Spannelement Clamping unit	Module d'arrosage Kühlmittelzufuhrelement Coolant supply unit	Page Seite Page
ML16-STAR-SB-16/20RG	ML16	> 11.60	ML16-FIX-16/22	ML16-JET-7/16	11.78

Star SB-20C/E

- + 1 outil (max 7)
- + 1 Werkzeug (max 7)
- + 1 tool (max 7)

ML16

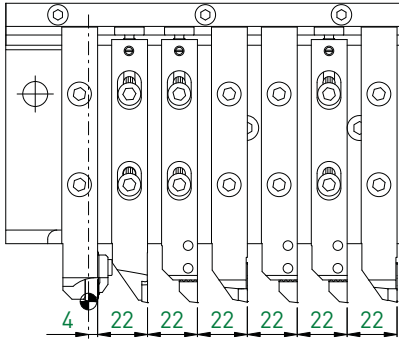

Outil \square 16 mm possible avec module de serrage
 Werkzeug \square 16 mm mit Spannelement möglich
 Tool \square 16 mm possible with clamping unit

Module d'arrosage (prend la place d'un outil)
 Kühlmittelzufuhrelement (nimmt den Platz eines Werkzeuges)
 Coolant supply unit (takes the place of one tool)



Support de base Grundhalter Base holder		Star SB-20C/E		Accessoires Zubehöre Accessories	
Art. N°	Porte-outils Halter Holders	Pages Seiten Pages	Module de serrage Spannelement Clamping unit	Module d'arrosage Kühlmittelzufuhrelement Coolant supply unit	Page Seite Page
ML16-STAR-SB20C/E	ML16	> 11.60	ML16-FIX-16/22	ML16-JET-7/16	11.78

- SR-16R** + 3 outils (max 9)
- Star SR-20R** + 3 Werkzeuge (max 9)
- SR-20RII** + 3 tools (max 9)

ML16

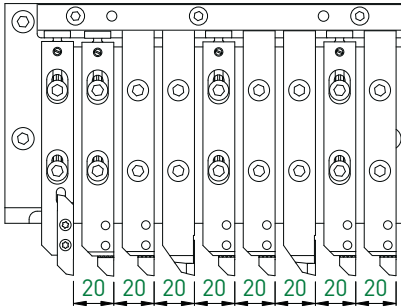

Outil ∇ 16 mm possible avec module de serrage
 Werkzeug ∇ 16 mm mit Spannelement möglich
 Tool ∇ 16 mm possible with clamping unit

Module d'arrosage (prend la place d'un outil)
 Kühlmittelzufuhrelement (nimmt den Platz eines Werkzeuges)
 Coolant supply unit (takes the place of one tool)



Support de base Grundhalter Base holder		Star SR-16R/SR-20R/SR-20RII		Accessoires Zubehöre Accessories	
Art. N°	Porte-outils Halter Holders	Pages Seiten Pages	Module de serrage Spannelement Clamping unit	Module d'arrosage Kühlmittelzufuhrelement Coolant supply unit	Page Seite Page
ML16-STAR-SR-20R	ML16	> 11.60	ML16-FIX-16/20	ML16-JET-7/16	11.78

Star **SR-20RIII**
SR-20J

+ 3 outils (max 9)
+ 3 Werkzeuge (max 9)
+ 3 tools (max 9)

ML16

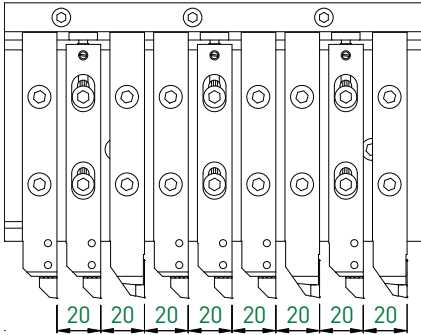

Outil \square 16 mm possible avec module de serrage
Werkzeug \square 16 mm mit Spannelement möglich
Tool \square 16 mm possible with clamping unit

Module d'arrosage (prend la place d'un outil)
Kühlmittelzufuhrelement (nimmt den Platz eines Werkzeuges)
Coolant supply unit (takes the place of one tool)



Support de base Grundhalter Base holder		Star SR-20RIII / SR-20J		Accessoires Zubehöre Accessories	
Art. N°	Porte-outils Halter Holders	Pages Seiten Pages	Module de serrage Spannelement Clamping unit	Module d'arrosage Kühlmittelzufuhrelement Coolant supply unit	Page Seite Page
ML16-STAR-SR-20RIII	ML16	> 11.60	ML16-FIX-16/20	ML16-JET-7/16	11.78
ML16-STAR-SR-20J	ML16				

Star SR-20RIV

- + 1 outil (max 8)
- + 1 Werkzeug (max 8)
- + 1 tool (max 8)

ML16

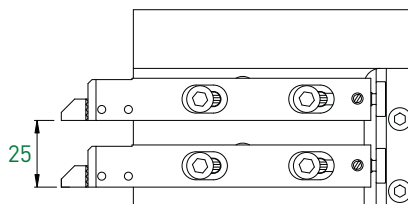
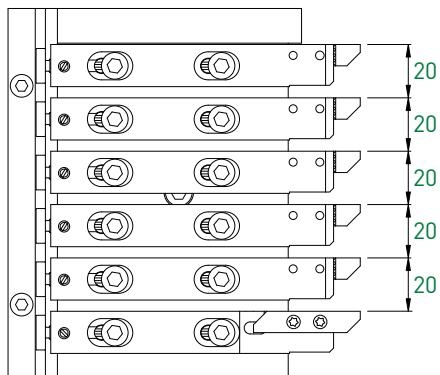

ML16-STAR-SR-20RIV-6T

ML16-STAR-SR-20RIV-2T

Support de base Grundhalter Base holder		Star SR-20RIV		Accessoires Zubehöre Accessories		
Type Typ Type	Art. N°	Porte-outils Halter Holders	Pages Seiten Pages	Module de serrage Spannelement Clamping unit	Module d'arrosage Kühlmittelzufuhrelement Coolant supply unit	Page Seite Page
2T	ML16-STAR-SR-20RIV-2T	ML16	> 11.60	-	ML16-JET-7/16	11.78
6T	ML16-STAR-SR-20RIV-6T					

MODU-LINE

Star SR-32J \varnothing max 32 mm
 + 1 outil (max 7)
 + 1 Werkzeug (max 7)
 + 1 tool (max 7)

\varnothing max 16 mm + 7 outils (max 13)
 + 7 Werkzeuge (max 13)
 + 7 tools (max 13)

ML16

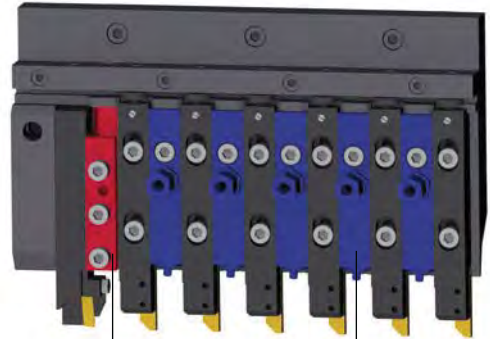
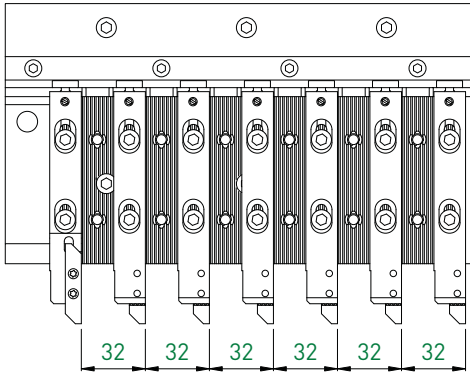

Outil \varnothing 16 mm possible avec module de serrage
 Werkzeug \varnothing 16 mm mit Spannelement möglich
 Tool \varnothing 16 mm possible with clamping unit

Module d'arrosage (prend la place d'un outil)
 Kühlmittelzufuhrelement (nimmt den Platz eines Werkzeuges)
 Coolant supply unit (takes the place of one tool)



Support de base Grundhalter Base holder		Star SR-32J		Accessoires Zubehöre Accessories	
Art. N°	Porte-outils Halter Holders	Pages Seiten Pages	Module de serrage Spannelement Clamping unit	Module d'arrosage Kühlmittelzufuhrelement Coolant supply unit	Page Seite Page
ML16-STAR-SR-32J	ML16	> 11.60	ML16-FIX-16/16	ML16-JET-7/16	11.78

Star SV-12 / 20

- + 2 outils (max 7)
- + 2 Werkzeuge (max 7)
- + 2 tools (max 7)

ML16

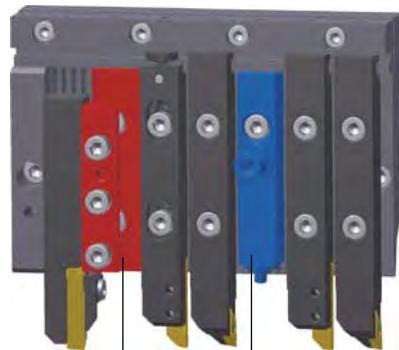
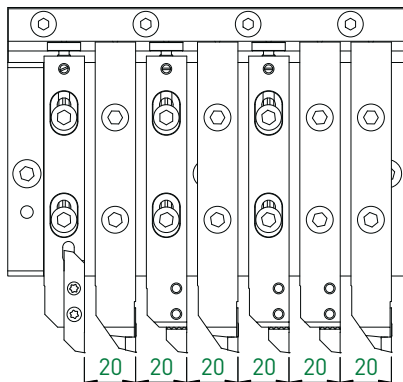

Outil 16 mm possible avec module de serrage
 Werkzeug 16 mm mit Spannelement möglich
 Tool 16 mm possible with clamping unit

Module d'arrosage (prend la place d'un outil)
 Kühlmittelzufuhrelement (nimmt den Platz eines Werkzeugs)
 Coolant supply unit (takes the place of one tool)



Support de base Grundhalter Base holder		Star SV-12 / 20		Accessoires Zubehöre Accessories	
Art. N°	Porte-outils Halter Holders	Pages Seiten Pages	Module de serrage Spannelement Clamping unit	Module d'arrosage Kühlmittelzufuhrelement Coolant supply unit	Page Seite Page
ML16-STAR-SV-12/20	ML16	> 11.60	ML16-FIX-16/20	ML16-JET-7/16	11.78

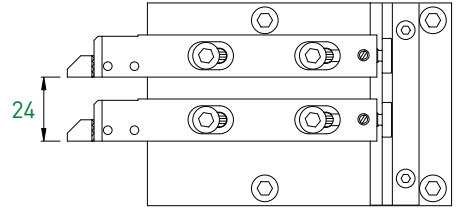
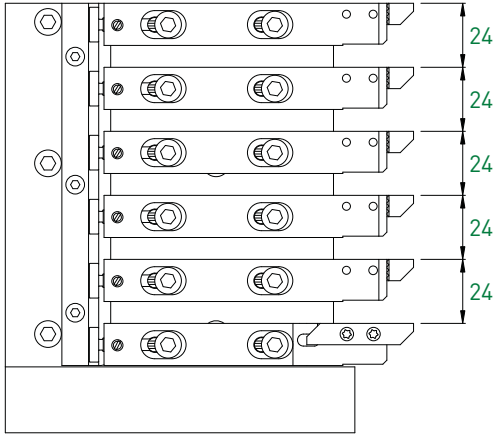

ML16-STAR-SW-20R-6T

ML16-STAR-SW-20R-2T

Support de base Grundhalter Base holder		Star SW-20R		Accessoires Zubehöre Accessories		
Type Typ Type	Art. N°	Porte-outils Halter Holders	Pages Seiten Pages	Module de serrage Spannelement Clamping unit	Module d'arrosage Kühlmittelezufuhrelement Coolant supply unit	Page Seite Page
2T	ML16-STAR-SW-20R-2T	ML16	> 11.60	-	ML16-JET-7/16	11.78
6T	ML16-STAR-SW-20R-6T			ML16-FIX-16/24		

Jet



Duo

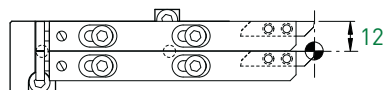
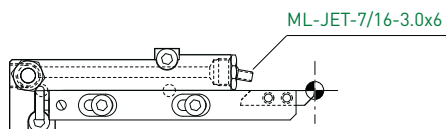

Jet



Duo

Support de base Grundhalter Base holder		Tornos DECO 7 / 10 EvoDECO 10		Accessoires Zubehöre Accessories		
Type Typ Type	Art. N°	Porte-outils Halter Holders	Pages Seiten Pages	Module de serrage Spannelement Clamping unit	Module d'arrosage Kühlmittelezufuhrelement Coolant supply unit	Page Seite Page
Jet	ML12-DEC010-JET	ML12	> 11.60	-	ML-JET-7/16...	11.79
Duo	ML12-DEC010-DUO				ML12-JET-5/16	11.78

Tornos **SwissNano**
SwissNano 7

+ 2 outils (max 6)
+ 2 Werkzeuge (max 6)
+ 2 tools (max 6)

ML12

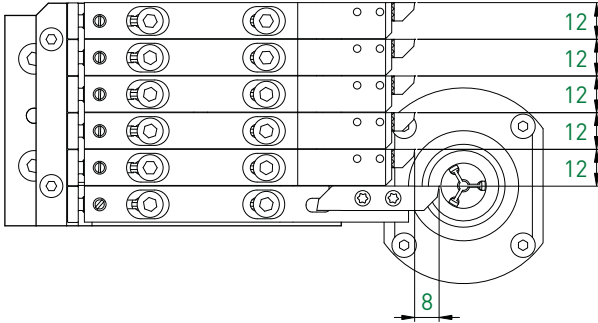

6T



6T

Support de base Grundhalter Base holder		Tornos SwissNano SwissNano 7		Accessoires Zubehöre Accessories		
Type Typ Type	Art. N°	Porte-outils Halter Holders	Pages Seiten Pages	Module de serrage Spannelement Clamping unit	Module d'arrosage Kühlmittelezufuhrelement Coolant supply unit	Page Seite Page
6T	ML12-SWISS-NANO-6T	ML12	> 11.60	-	ML12-JET-5/16	11.78

Tornos **SwissNano**
SwissNano 7

ML12

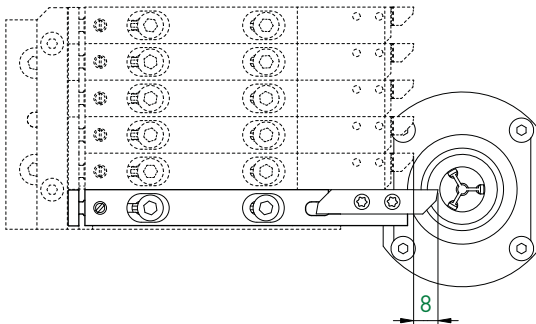

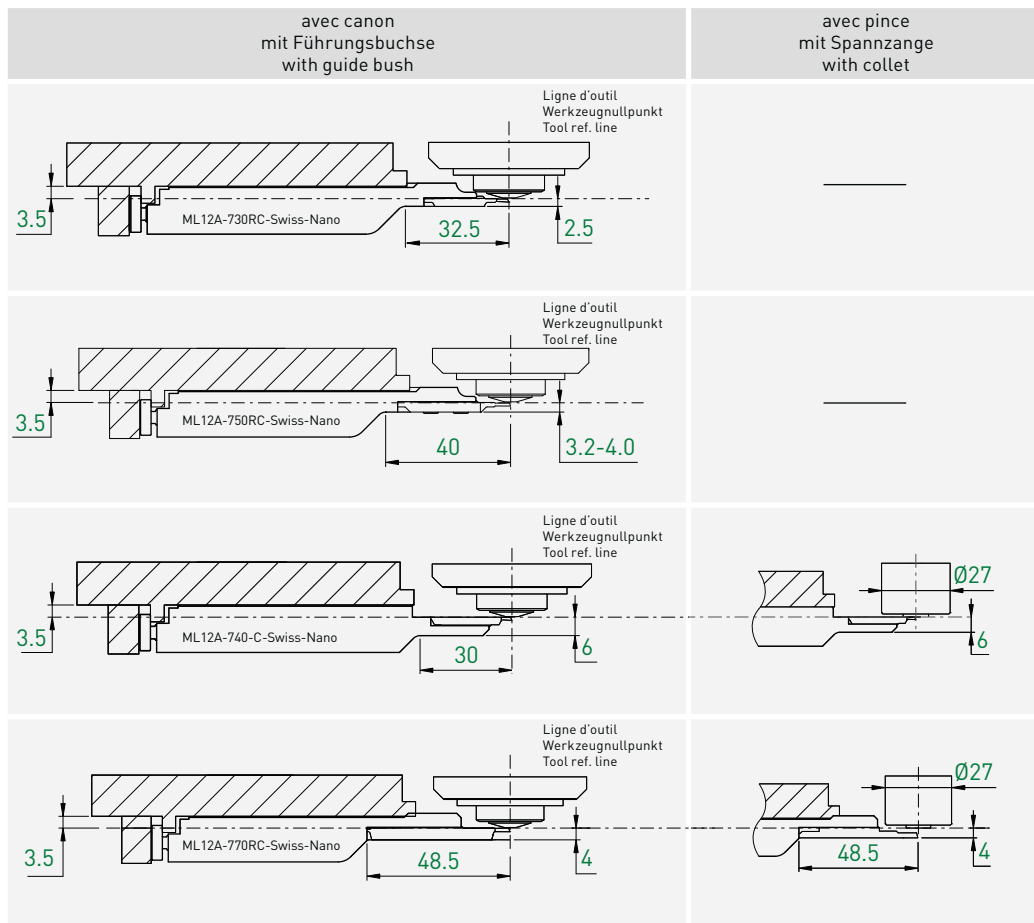

Type de machine Maschinen-Typ Type of machine	Porte-outils Halter Holders	Art. N°	Plaquettes Wendepplatten Inserts	Pages Seiten Pages
SwissNano	ML12	ML12A-730RC-SWISS-NANO	731R... / 731RSF	1.39-45 / 2.20
		ML12A-750RC-SWISS-NANO	751R... / 751RDSF	1.88-97 / 2.20
		ML12A-740-C-SWISS-NANO	741... / 741SF	1.32-38 / 2.12
		ML12A-770RC-SWISS-NANO	771R...	1.137-140

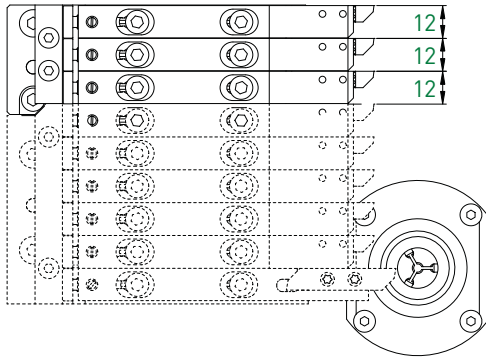
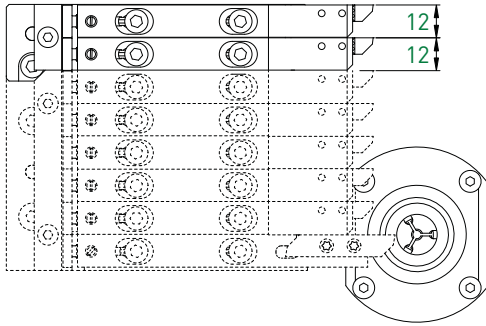

Support de base Grundhalter Base holder		Tornos SwissNano SwissNano 7		Accessoires Zubehöre Accessories		
Type Typ Type	Art. N°	Porte-outils Halter Holders	Pages Seiten Pages	Module de serrage Spannelement Clamping unit	Module d'arrosage Kühlmitelzufuhrelement Coolant supply unit	Page Seite Page
2T	ML12-SWISS-NANO-2T	ML12	> 11.60	-	ML12-JET-5/16	11.78
3T	ML12-SWISS-NANO-3T					

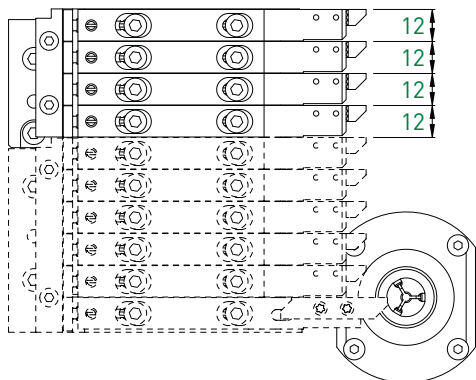

Support de base Grundhalter Base holder		Tornos SwissNano 7		Accessoires Zubehöre Accessories		
Type Typ Type	Art. N°	Porte-outils Halter Holders	Pages Seiten Pages	Module de serrage Spannelement Clamping unit	Module d'arrosage Kühlmittelfuhrlement Coolant supply unit	Page Seite Page
4T	ML12-SWISS-NANO-7-4T	ML12	> 11.60	-	ML12-JET-5/16	11.78

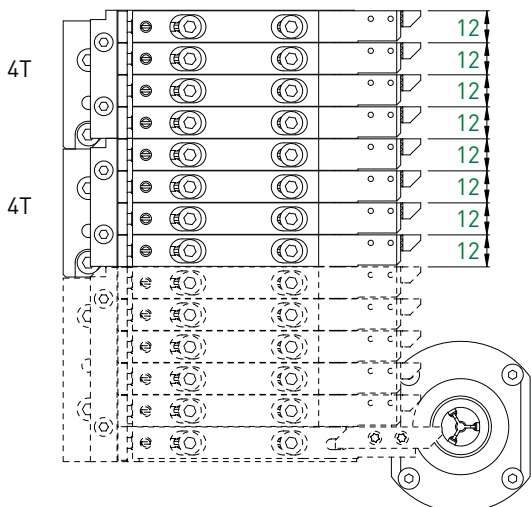

Possibilité de coupler 2 modules 4T
 2 Module 4T können gekoppelt werden
 Possibility to couple 2 modules 4T

Tornos DT 13

+ 3 outils (max 9)
 + 3 Werkzeuge (max 9)
 + 3 tools (max 9)

ML12

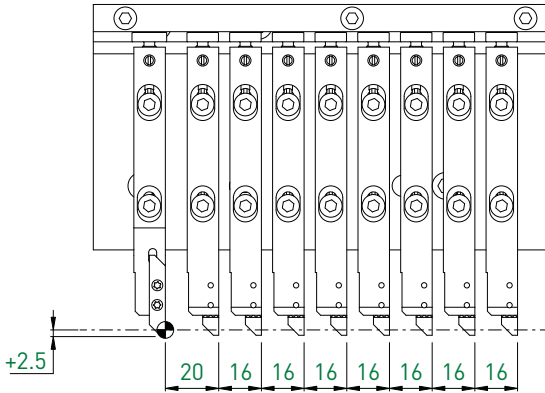

Support de base Grundhalter Base holder		Tornos DT 13		Accessoires Zubehöre Accessories		
Type Typ Type	Art. N°	Porte-outils Halter Holders	Pages Seiten Pages	Module de serrage Spannelement Clamping unit	Module d'arrosage Kühlmittelfuhrelement Coolant supply unit	Page Seite Page
9T	ML12-DT13-2020206-9T	ML12	> 11.60	-	ML12-JET-5/16	11.78

Tornos CT 20

- + 1 outil (max 7)
- + 1 Werkzeug (max 7)
- + 1 tool (max 7)

ML12

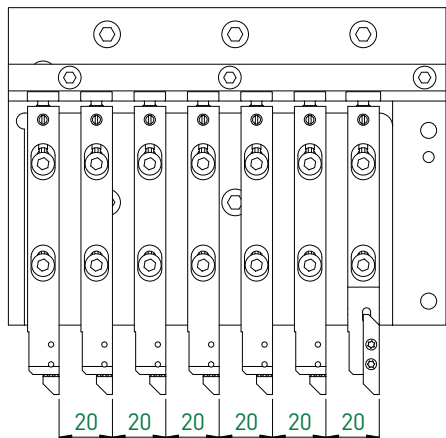

Support de base Grundhalter Base holder		Tornos CT 20		Accessoires Zubehöre Accessories		
Type Typ Type	Art. N°	Porte-outils Halter Holders	Pages Seiten Pages	Module de serrage Spannelement Clamping unit	Module d'arrosage Kühlmitelzufuhrelement Coolant supply unit	Page Seite Page
7T	ML12-CT20-2020019-7T	ML12	> 11.60	-	ML12-JET-5/16	11.78

Tornos GT 13

- + 5 outils (max 12)
- + 5 Werkzeuge (max 12)
- + 5 tools (max 12)

ML12

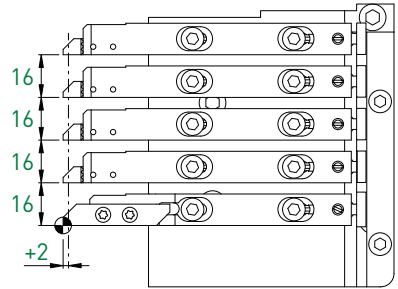
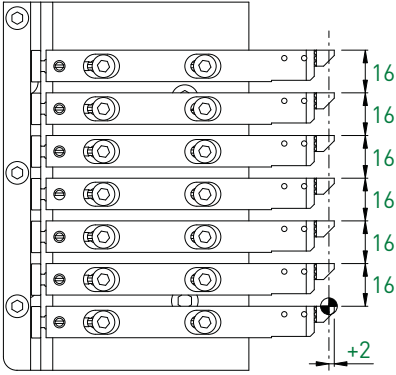



ML12-GT13-390223-7T



ML12-GT13-390224-5T

Support de base Grundhalter Base holder		Tornos GT 13		Accessoires Zubehöre Accessories		
Type Typ Type	Art. N°	Porte-outils Halter Holders	Pages Seiten Pages	Module de serrage Spannelement Clamping unit	Module d'arrosage Kühlmittelezufuhrelement Coolant supply unit	Page Seite Page
5T	ML12-GT13-390224-5T	ML12	> 11.60	-	ML12-JET-5/16	11.78
7T	ML12-GT13-390223-7T					

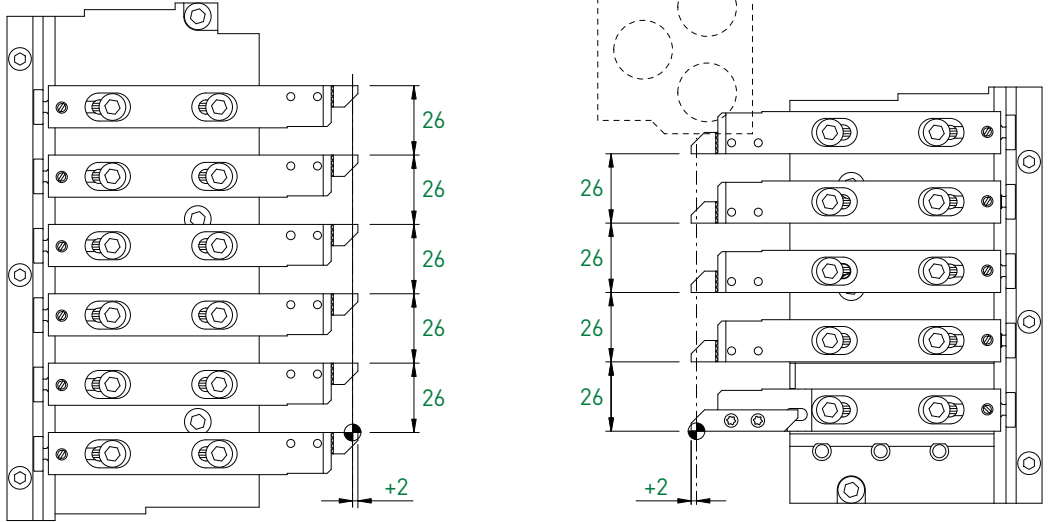

1 serrage ML16-FIX-16 pour outil \square 16 mm inclus
 1 Spannung ML16-FIX-16 für Werkzeug \square 16 mm inbegriffen
 1 clamping ML16-FIX-16 for tool \square 16 mm included



ML16-GT26-386209-6T



ML16-GT26-386210-5T

Support de base Grundhalter Base holder		Tornos GT 26		Accessoires Zubehöre Accessories		
Type Typ Type	Art. N°	Porte-outils Halter Holders	Pages Seiten Pages	Module de serrage Spannelement Clamping unit	Module d'arrosage Kühlmitelzufuhrelement Coolant supply unit	Page Seite Page
5T	ML16-GT26-386210-5T	ML16	> 11.60	-	ML16-JET-7/16	11.78
6T	ML16-GT26-386209-6T					

Tornos GT 32

+ 9 outils
 max + 9 Werkzeuge
 + 9 tools

ML16

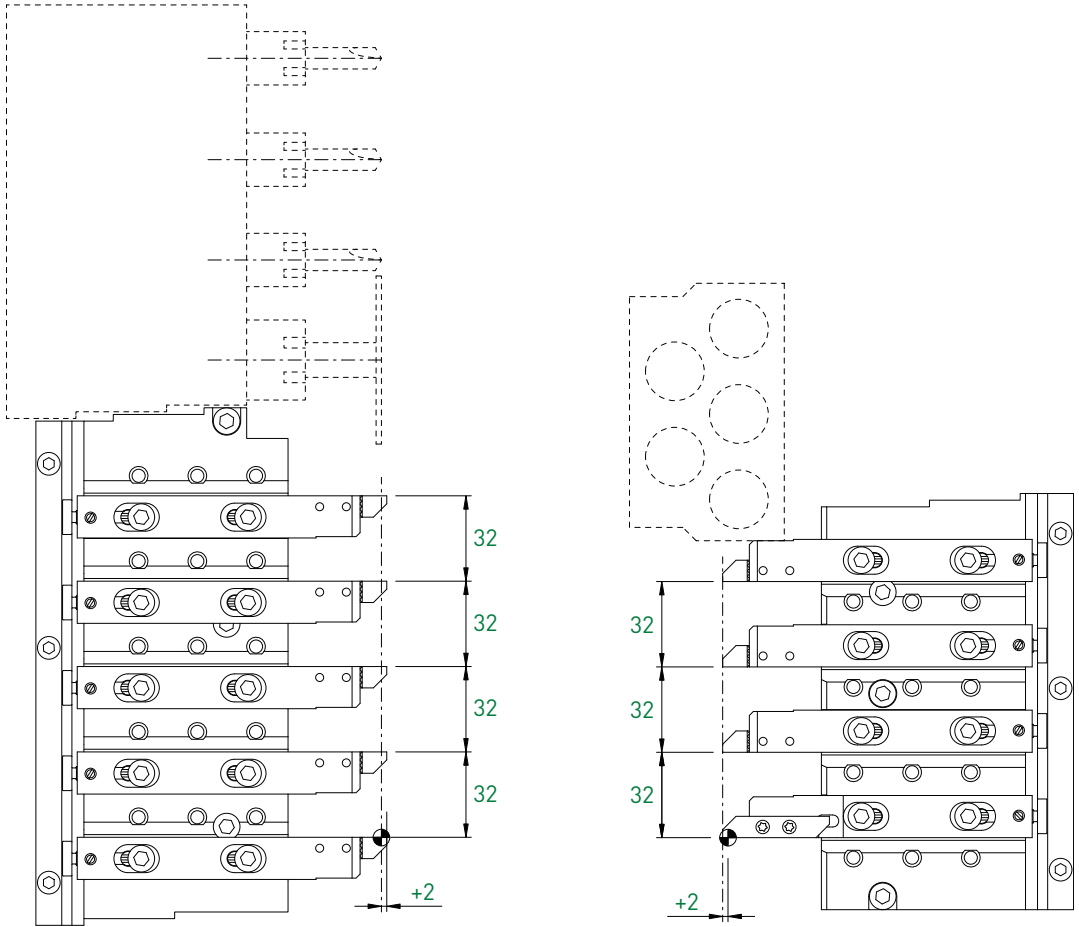

Holder ML16



Holder □16



Holder ML16



Holder □16



ML16-GT32-386209-5T



ML16-GT32-386210-4T

Support de base Grundhalter Base holder		Tornos GT 32		Accessoires Zubehöre Accessories			
Type Typ Type	Art. N°	Porte-outils Halter Holders	Pages Seiten Pages	Module de serrage Spannelement Clamping unit		Module d'arrosage Kühlmittelzufuhrelement Coolant supply unit	Pages Seiten Pages
4T	ML16-GT32-386210-4T	ML16	> 11.60	1x inclus 1x inbegriffen 1x included		ML16-JET-7/16	11.78
5T	ML16-GT32-386209-5T			Option ML16-FIX-16			

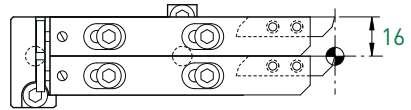
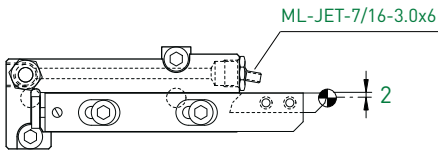

Jet



Duo

Support de base Grundhalter Base holder		Tornos DECO 13 / EvoDECO 16		Accessoires Zubehöre Accessories		
Type Typ Type	Art. N°	Porte-outils Halter Holders	Pages Seiten Pages	Module de serrage Spannelement Clamping unit	Module d'arrosage Kühlmittelzufuhrelement Coolant supply unit	Page Seite Page
Jet	ML16-DECO13-JET	ML16	> 11.60	-	ML-JET-7/16...	11.79
Duo	ML16-DECO13-DUO				ML16-JET-7/16	11.78

Jet



Duo

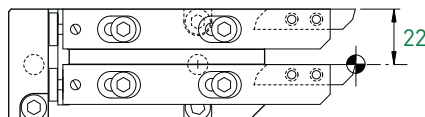
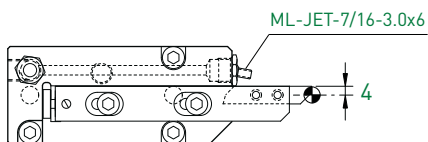

Jet



Duo

Support de base Grundhalter Base holder		Tornos DECO 20 / 26 EvoDECO 20 / 32		Accessoires Zubehöre Accessories		
Type Typ Type	Art. N°	Porte-outils Halter Holders	Pages Seiten Pages	Module de serrage Spannelement Clamping unit	Module d'arrosage Kühlmittelzufuhrelement Coolant supply unit	Page Seite Page
Jet	ML16-DECO20-JET	ML16	> 11.60	-	ML-JET-7/16...	11.79
Duo	ML16-DECO20-DUO				ML16-JET-7/16	11.78

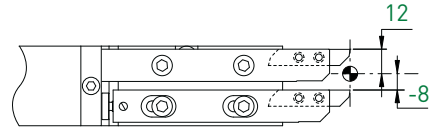
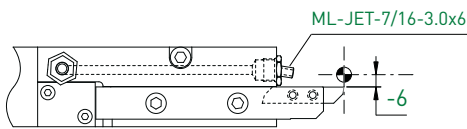

Jet



Duo

Support de base Grundhalter Base holder		Tornos SIGMA 20 / 32		Accessoires Zubehöre Accessories		
Type Typ Type	Art. N°	Porte-outils Halter Holders	Pages Seiten Pages	Module de serrage Spannelement Clamping unit	Module d'arrosage Kühlmittelzufuhrelement Coolant supply unit	Page Seite Page
Jet	ML16-S20-JET	ML16	> 11.60	-	ML-JET-7/16...	11.79
Duo	ML16-S20-DUO				ML16-JET-7/16	11.78

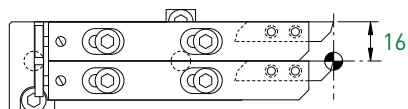
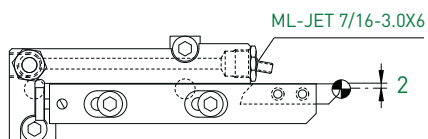

Jet



Duo

Support de base Grundhalter Base holder		Tornos Swiss ST 26		Accessoires Zubehöre Accessories		
Type Typ Type	Art. N°	Porte-outils Halter Holders	Pages Seiten Pages	Module de serrage Spannelement Clamping unit	Module d'arrosage Kühlmittelzufuhrelement Coolant supply unit	Page Seite Page
Jet	ML16-SWISS-ST26-JET	ML16	> 11.60	-	ML-JET-7/16...	11.79
Duo	ML16-SWISS-ST26-DUO				ML16-JET-7/16	11.78

Tornos DT 26

- + 1 outil (max 7)
- + 1 Werkzeug (max 7)
- + 1 tool (max 7)

ML16

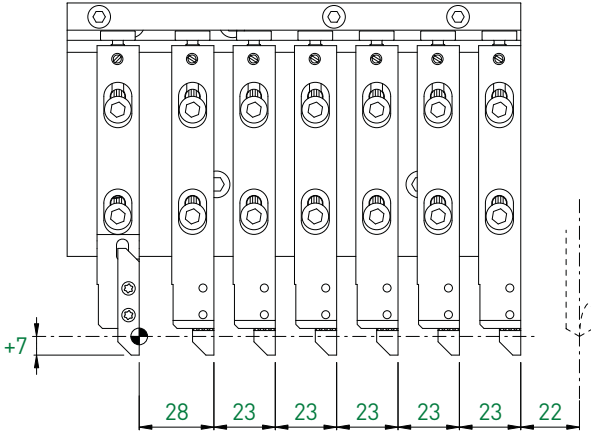

Support de base Grundhalter Base holder		Tornos DT 26		Accessoires Zubehöre Accessories		
Type Typ Type	Art. N°	Porte-outils Halter Holders	Pages Seiten Pages	Module de serrage Spannelement Clamping unit	Module d'arrosage Kühlmitelzufuhrelement Coolant supply unit	Page Seite Page
7T	ML16-DT26-2020206-7T	ML16	> 11.60	-	ML16-JET-7/16	11.78

Tsugami B074

- + 3 outils (max 6)
- + 3 Werkzeuge (max 6)
- + 3 tools (max 6)

ML12

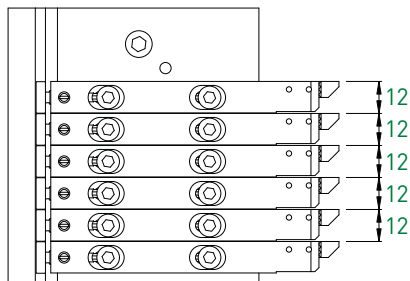

Support de base Grundhalter Base holder		Tsugami B074		Accessoires Zubehöre Accessories		
Type Typ Type	Art. N°	Porte-outils Halter Holders	Pages Seiten Pages	Module de serrage Spannelement Clamping unit	Module d'arrosage Kühlmittelzufuhrelement Coolant supply unit	Page Seite Page
6T	ML12-B074-1-6T	ML12	> 11.60	-	ML12-JET-5/16	11.78

Tsugami B075

- + 5 outils (max 8)
- + 5 Werkzeuge (max 8)
- + 5 tools (max 8)

ML12

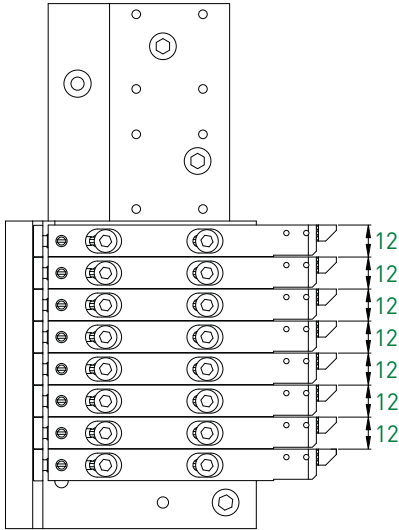

Support de base Grundhalter Base holder		Tsugami B075		Accessoires Zubehöre Accessories		
Type Typ Type	Art. N°	Porte-outils Halter Holders	Pages Seiten Pages	Module de serrage Spannelement Clamping unit	Module d'arrosage Kühlmittelzufuhrelement Coolant supply unit	Page Seite Page
8T	ML12-B075-1-8T	ML12	> 11.60	-	ML12-JET-5/16	11.78

Tsugami P034

+ 3 outils (max 9)
 + 3 Werkzeuge (max 9)
 + 3 tools (max 9)

ML12

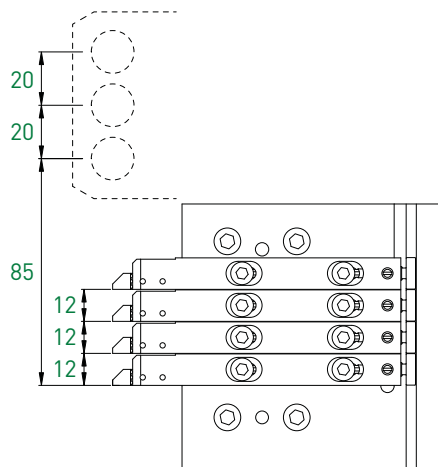
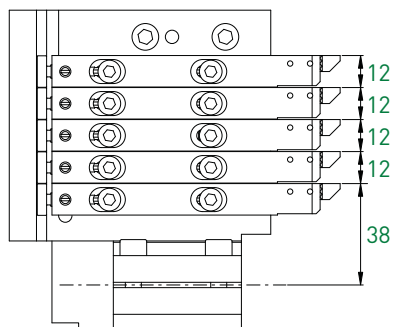

ML12-P034-1-5T

ML12-P034-2-4T

Support de base Grundhalter Base holder		Tsugami P034		Accessoires Zubehöre Accessories		
Type Typ Type	Art. N°	Porte-outils Halter Holders	Pages Seiten Pages	Module de serrage Spannelement Clamping unit	Module d'arrosage Kühlmittelzufuhrelement Coolant supply unit	Page Seite Page
4T	ML12-P034-2-4T	ML12	> 11.60	-	ML12-JET-5/16	11.78
5T	ML12-P034-1-5T					

Tsugami P034

max + 17 outils
+ 17 Werkzeuge
+ 17 tools

ML12

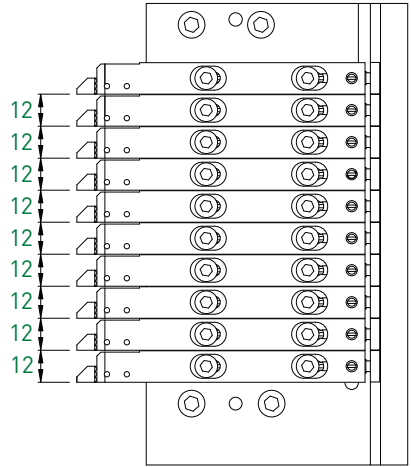
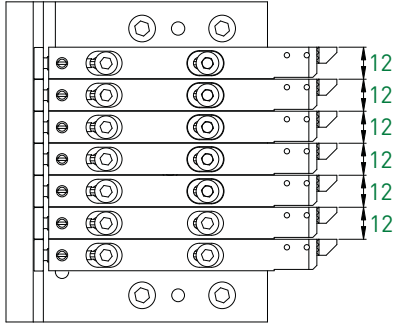

ML12-P034-1-7T

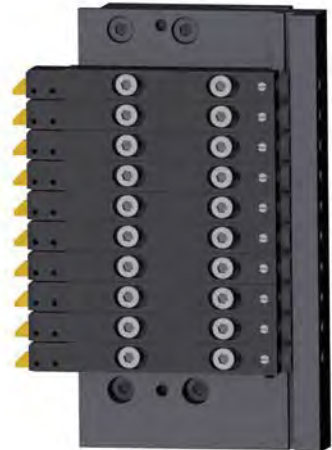

ML12-P034-2-10T



ML12-P034-1-7T



ML12-P034-2-10T

Support de base Grundhalter Base holder		Tsugami P034		Accessoires Zubehöre Accessories		
Type Typ Type	Art. N°	Porte-outils Halter Holders	Pages Seiten Pages	Module de serrage Spannelement Clamping unit	Module d'arrosage Kühlmittelzufuhrelement Coolant supply unit	Page Seite Page
7T	ML12-P034-1-7T	ML12	> 11.60	-	ML12-JET-5/16	11.78
10T	ML12-P034-2-10T					

Les différents types de porte-outils
Die verschiedenen Haltertypen
The various types of holders

Type Standard

ML12A-740



Type -D

ML12A-740-D



Type -JET-D

ML12A-740-JET-D

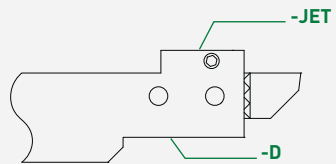

Type -JET

ML12A-740-JET

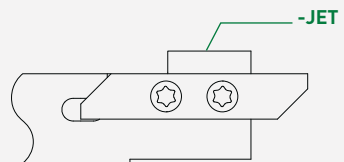

Compatibilité
 Kompatibilität
 Compatibility

OK

KO

-JET-D -D

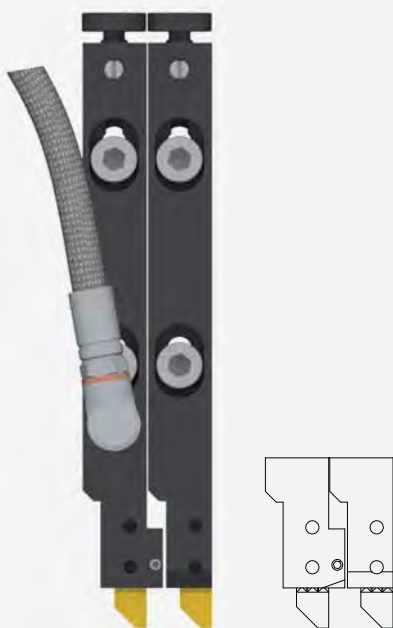

-JET-D -Standard



MIX

TYPE D

-Standard -JET-D -D



-JET-D -D -JET-D -D



Exceptions
Ausnahmen
Exceptions

Exception ML12

Exception ML16



≥ 15 mm = Total compatibility

≥ 20 mm = Total compatibility

Brochure JET-Line:

Système de distribution du liquide de refroidissement pour haute pression

JET-Line Broschüre:

Kühlmittelverteilungssystem für hohen Druck

JET-Line brochure:

Coolant distribution system for high pressure

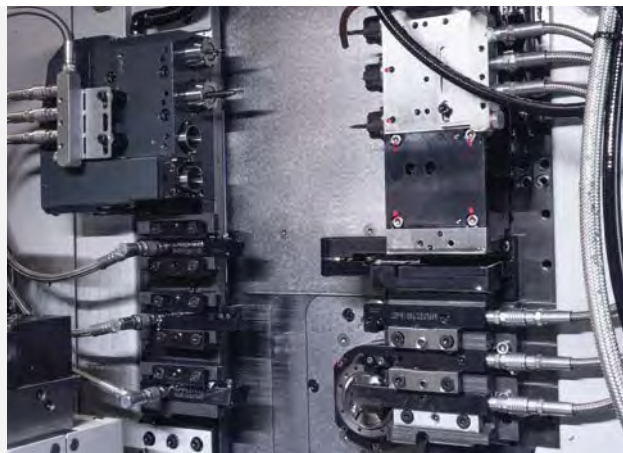

Porte-outils

Halter

Holders

ML12 / ML16

Système de fixation
Befestigungssystem
Clamping system

A = réglable
einstellbar
adjustable

F = longueur fixe
fixlänge
fixed length

ML12A

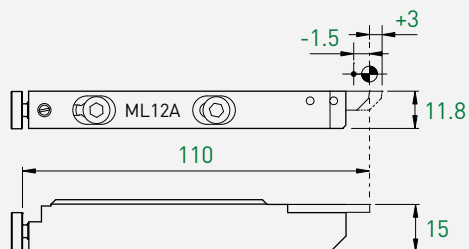

ML12F

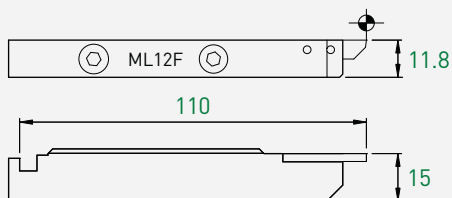

ML16A

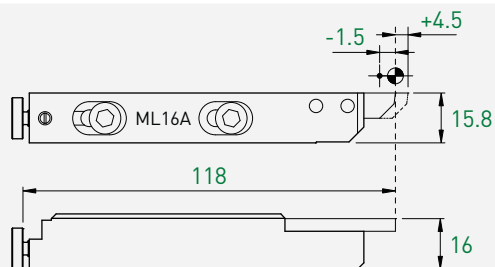

ML16F

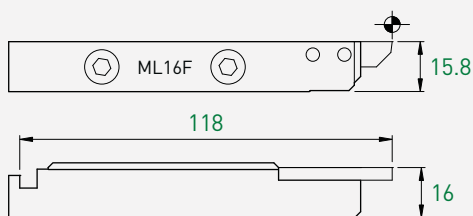

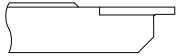

TOP-Line
741-747 > 1.32

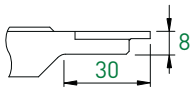

TOP-Line
741-747 > 1.32

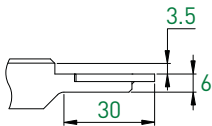

TOP-Line
741 > 1.32-1.38



TOP-Line
761-767 > 1.78

Standard	-D	-JET-D
Art. N°	Art. N°	Art. N°
ML12	ML12	ML12
ML12A-740	ML12A-740-D	ML12A-740-JET-D
ML12F-740	ML12F-740-D	-
ML16	ML16	ML16
ML16A-740	ML16A-740-D	ML16A-740-JET-D
ML16F-740	-	-

ML12	ML12	ML12
ML12A-740-C	ML12A-740-C-D	ML12A-740-C-JET-D
ML12F-740-C	ML12F-740-C-D	-

ML12	ML12	ML12
ML12A-740-C-R04	-	-
ML12A-740-C-SWISS-NANO	-	-

ML12	ML12	ML12
ML12A-760	ML12A-760-D	ML12A-760-JET-D
ML12F-760	ML12F-760-D	-
ML16	ML16	ML16
ML16A-760	ML16A-760-D	ML16A-760-JET-D
ML16F-760	-	-

Porte-plaquettes

WSP-Halter



Insert holders

TOP-Line



TOP-Line
761-767

> 1.78

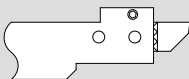
Standard	-D	-JET-D
		
Art. N°	Art. N°	Art. N°
ML16	ML16	ML16
ML16A-760-C	ML16A-760-C-D	-
ML16F-760-C	-	-



TOP-Line
781

> 1.135

ML16	ML16	ML16
-	ML16A-780-C-D	-

Porte-plaquettes

WSP-Halter



Insert holders

TURN-Line



TURN-Line
347-349

> 6.12

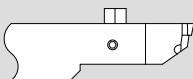
Standard	-D	-JET-D
		
Art. N°	Art. N°	Art. N°
ML12	ML12	ML12
ML12A-340	ML12A-340-D	ML12A-340-JET-D
ML12F-340	ML12F-340-D	-
ML16	ML16	ML16
ML16A-340	ML16A-340-D	ML16A-340-JET-D
ML16F-340	-	-

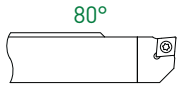

ISO-Line
CC...-0602.. > 7.16

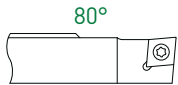

ISO-Line
CC...-09T3.. > 7.16

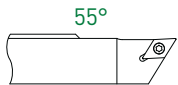

ISO-Line
DC...-0702.. > 7.30

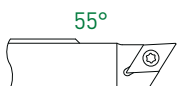

ISO-Line
DC...-11T3.. > 7.30

Standard	-D	-JET-D
Art. N°	Art. N°	Art. N°
ML12	ML12	ML12
ML12A-SCLCR06	ML12A-SCLCR06-D	ML12A-SCLCR06-JET-D
ML12F-SCLCR06	ML12F-SCLCR06-D	-
ML16	ML16	ML16
ML16A-SCLCR06	ML16A-SCLCR06-D	ML16A-SCLCR06-JET-D
ML16F-SCLCR06	ML16F-SCLCR06-D	-

ML12	ML12	ML12
ML12A-SCLCR09	ML12A-SCLCR09-D	ML12A-SCLCR09-JET-D
ML12F-SCLCR09	ML12F-SCLCR09-D	-
ML16	ML16	ML16
ML16A-SCLCR09	ML16A-SCLCR09-D	ML16A-SCLCR09-JET-D
ML16F-SCLCR09	ML16F-SCLCR09-D	-

ML12	ML12	ML12
ML12A-SDJCR07	ML12A-SDJCR07-D	ML12A-SDJCR07-JET-D
ML12F-SDJCR07	ML12F-SDJCR07-D	-
ML16	ML16	ML16
ML16A-SDJCR07	ML16A-SDJCR07-D	ML16A-SDJCR07-JET-D
ML16F-SDJCR07	ML16F-SDJCR07-D	-

ML12	ML12	ML12
ML12A-SDJCR11	ML12A-SDJCR11-D	ML12A-SDJCR11-JET-D
ML12F-SDJCR11	ML12F-SDJCR11-D	-
ML16	ML16	ML16
ML16A-SDJCR11	ML16A-SDJCR11-D	ML16A-SDJCR11-JET-D
ML16F-SDJCR11	ML16F-SDJCR11-D	-

Porte-plaquettes

WSP-Halter

Insert holders

ISO-Line

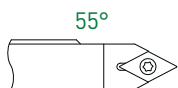

ISO-Line
DC..-11T3.. > 7.30

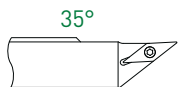

ISO-Line
VC..-1103.. > 7.44

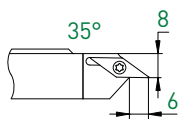

ISO-Line
VC..-1103.. > 7.44

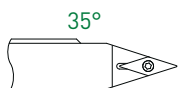

ISO-Line
VC..-1103.. > 7.44

Standard	-D	-JET-D
Art. N°	Art. N°	Art. N°
ML12	ML12	ML12
ML12A-SDNCN11	ML12A-SDNCN11-D	-
ML12F-SDNCN11	ML12F-SDNCN11-D	-
ML16	ML16	ML16
ML16A-SDNCN11	ML16A-SDNCN11-D	-
ML16F-SDNCN11	ML16F-SDNCN11-D	-

ML12	ML12	ML12
ML12A-SVJCR11	ML12A-SVJCR11-D	ML12A-SVJCR11-JET-D
ML12F-SVJCR11	ML12F-SVJCR11-D	-
ML16	ML16	ML16
ML16A-SVJCR11	ML16A-SVJCR11-D	ML16A-SVJCR11-JET-D
ML16F-SVJCR11	ML16F-SVJCR11-D	-

-	ML12	ML12
ML12A-SV-CR11	ML12A-SV-CR11-D	-
ML16	ML16	ML16
ML16A-SV-CR11	ML16A-SV-CR11-D	-

ML12	ML12	ML12
ML12A-SVVCN11	ML12A-SVVCN11-D	-
ML12F-SVVCN11	ML12F-SVVCN11-D	-
ML16	ML16	ML16
ML16A-SVVCN11	ML16A-SVVCN11-D	-
ML16F-SVVCN11	ML16F-SVVCN11-D	-

MODU-LINE

Porte-plaquettes
WSP-Halter
Insert holders

ISO-Line

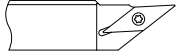

ISO-Line
VC..-1303.. > 7.46

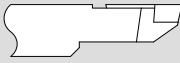
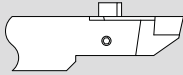
Standard	-D	-JET-D
		
Art. N°	Art. N°	Art. N°
ML12	ML12	ML12
-	ML12A-SVJCR13-D	-
ML16	ML16	ML16
-	ML16A-SVJCR13-D	ML16A-SVJCR13-JET-D

Porte-plaquettes
WSP-Halter
Insert holders

EVOCUT-Line

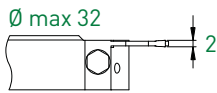

EVOCUT-Line
ET20.. > 8.12

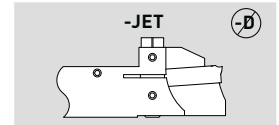

Art. N°	Art. N°	Art. N°
ML16	ML16	ML16
-	-	ML16A-ET20-JET32

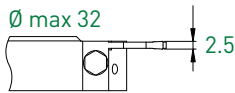

EVOCUT-Line
ET25.. > 8.12

ML16	ML16	ML16
-	-	ML16A-ET25-JET32

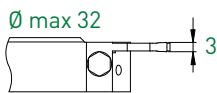

EVOCUT-Line
ET30.. > 8.12

ML16	ML16	ML16
-	-	ML16A-ET30-JET32

Porte-plaquettes

WSP-Halter

Insert holders

CUT-Line

Standard

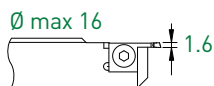
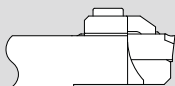

CUT-Line
CUT16..

> 9.14

Art. N°	Art. N°	Art. N°
ML12	ML12	ML12
ML12A-CUT16	-	-
ML12F-CUT16	-	-
ML16	ML16	ML16
ML16A-CUT16	-	-
ML16F-CUT16	-	-

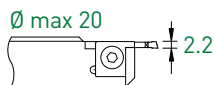

CUT-Line
CUT22..

> 9.14

ML12	ML12	ML12
ML12A-CUT22	-	-
ML12F-CUT22	-	-
ML16	ML16	ML16
ML16A-CUT22	-	-
ML16F-CUT22	-	-

MODU-LINE

Porte-plaquettes
WSP-Halter
Insert holders

PRO-Line

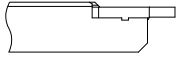

PRO-Line
642-647 > 3.08

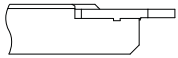

PRO-Line
661 > 3.34

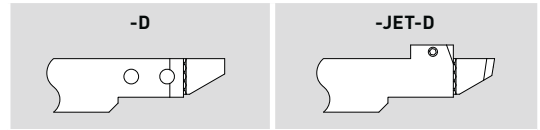

Art. N°	Art. N°	Art. N°
ML12	ML12	ML12
-	ML12A-640-D	ML12A-640-JET-D
ML16	ML16	ML16
-	ML16A-640-D	ML16A-640-JET-D

ML12	ML12	ML12
-	ML12A-660-D	ML12A-660-JET-D
ML16	ML16	ML16
-	ML16A-660-D	ML16A-660-JET-D

Porte-plaquettes
WSP-Halter
Insert holders

ECO-Line

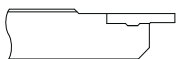

ECO-Line
261-266 > 4.08

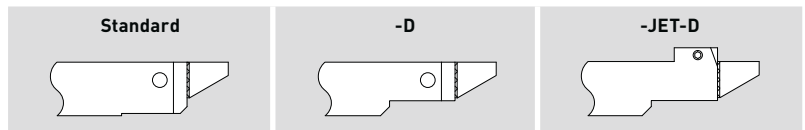

Standard	-D	-JET-D
Art. N°	Art. N°	Art. N°
ML12	ML12	ML12
ML12A-260	ML12A-260-D	ML12A-260-JET-D
ML12F-260	ML12F-260-D	-
ML16	ML16	ML16
ML16A-260	ML16A-260-D	ML16A-260-JET-D
ML16F-260	-	-

Porte-outils

Halter

Holders

IN-Line

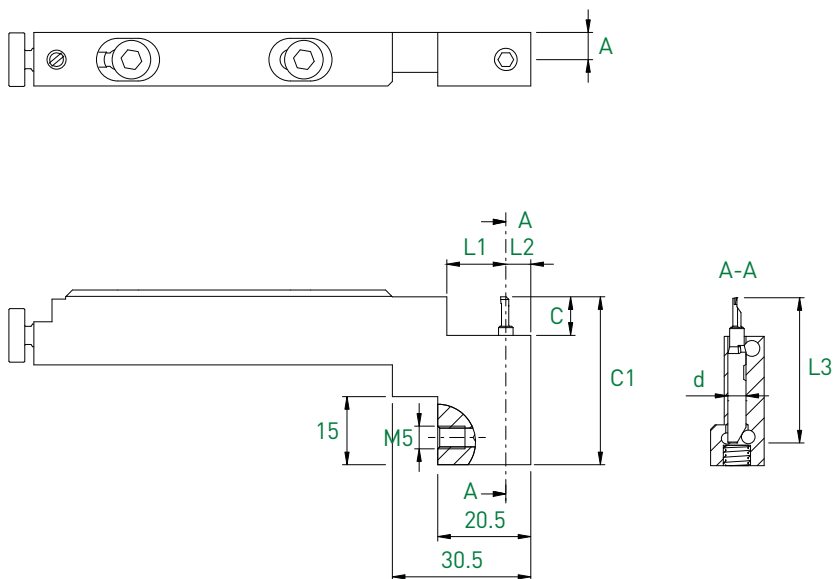

							ML12
d	Compatible bars L3	C	C1	A	L1	L2	Art. N°
4	BB4R...	32	8.5	37	6	13	ML12A-BHK4N-32R-D
	BF4R...	37	13.5	42	6	13	ML12A-BHK4N-37R-D
		42	18.5	47	6	13	ML12A-BHK4N-42R-D

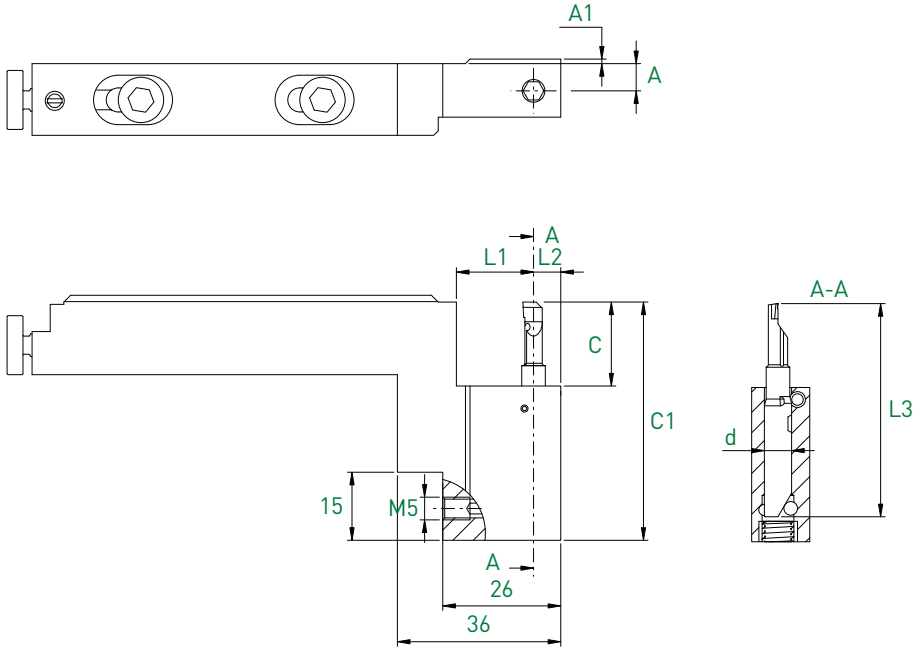

									ML16
d	Compatible bars L3	C	C1	A	A1	L1	L2	Art. N°	
4	BB4R...	32	8.5	37	6	-	17.5	5.5	ML16A-BHK4N-32R-D
	BF4R...	37	13.5	42	6	-	17.5	5.5	ML16A-BHK4N-37R-D
		42	18.5	47	6	-	17.5	5.5	ML16A-BHK4N-42R-D

									ML16
d	Compatible bars L3	C	C1	A	A1	L1	L2	Art. N°	
6	BB4R...	47	18.5	52.5	6	1	17	6	ML16A-BHK6N-47R-D
	BF4R...	57	28.5	62.5	6	1	17	6	ML16A-BHK6N-57R-D

Porte-outils

Halter

Holder

TOOLING-Line

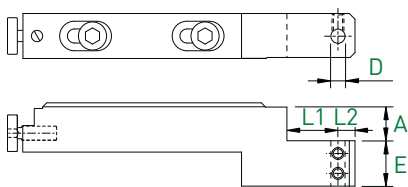

					ML12
A	D	E	L1	L2	Art. N°
8	3	12	13	6	ML12A-2440-8-3
8	4	12	13	6	ML12A-2440-8-4
8	5	12	13	6	ML12A-2440-8-5
12	6	12	13	6	ML12A-2440-12-6

					ML16
A	D	E	L1	L2	Art. N°
12	3	16	18	6	ML16A-2440-12-3
12	4	16	18	6	ML16A-2440-12-4
12	5	16	18	6	ML16A-2440-12-5
12	6	16	18	6	ML16A-2440-12-6
18	8	16	18	6	ML16A-2440-18-8

Porte-molettes

Rändelhalter

Knurl holders

TOOLING-Line

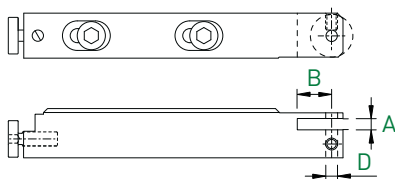

			ML12
A	D	B	Art. N°
4	4	8	ML12A-2402-44

			ML16
A	D	B	Art. N°
4	4	11	ML16A-2402-44

MODU-LINE

Porte-plaquettes – Coupe déportée & contre-opération

WSP-Halter – Versetztes Schneiden & Gegenspindel

Insert holders – Cut off line & cut on subspindle

Coupe à droite déportée ou usinage
à gauche sur contre-broche

Rechtsschneidend versetzt oder
linksschneidend auf Gegenspindel

Right hand cut off line or left hand
cut on subspindle

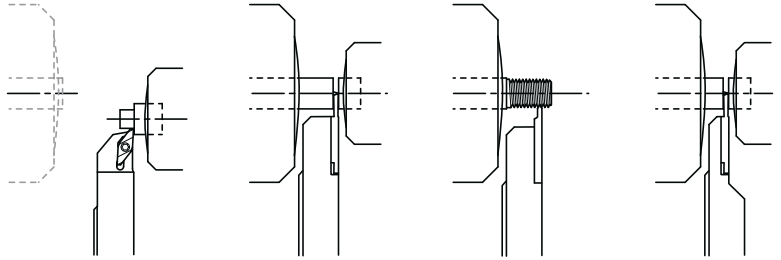

TURN-Line
ISO-Line

TOP-Line
EVOCUT-Line
CUT-Line
PRO-Line
ECO-Line

TOP-Line
EVOCUT-Line
CUT-Line
PRO-Line
ECO-Line

TOP-Line
PRO-Line
ECO-Line

Porte-plaquettes – Coupe déportée & contre-opération

WSP-Halter – Versetztes Schneiden & Gegenspindel

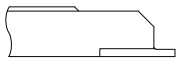

Insert holders – Cut off line & cut on subspindle

TOP-Line



TOP-Line
731-737

> 1.32

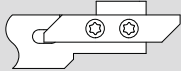



Standard	-D	-JET-D
		
Art. N°	Art. N°	Art. N°
ML12	ML12	ML12
ML12A-730-V	ML12A-730-V-D	ML12A-730-V-JET-D
ML16	ML16	ML16
ML16A-730-V	ML16A-730-V-D	ML16A-730-V-JET-D

Porte-plaquettes – Coupe déportée & contre-opération

WSP-Halter – Versetztes Schneiden & Gegenspindel

Insert holders – Cut off line & cut on subspindle

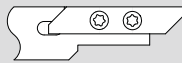
TOP-Line

Standard	-D	-JET 
		
Art. N°	Art. N°	Art. N°
ML12	ML12	ML12
ML12A-730RC	-	ML12A-730RC-JET

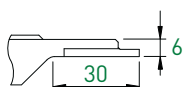

TOP-Line 731R > 1.39

ML16	ML16	ML16
ML16A-730RC	ML16A-730RC-D	ML16A-730RC-JET-D

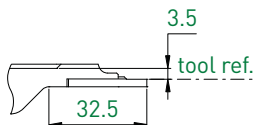

TOP-Line 731R > 1.39

ML12	ML12	ML12
ML12A-730RC-R04	-	-
ML12A-730RC-SWISS-NANO	-	-



TOP-Line 751-757 > 1.78

ML12	ML12	ML12
ML12A-750-V	ML12A-750-V-D	ML12A-750-V-JET-D
ML16	ML16	ML16
ML16A-750-V	ML16A-750-V-D	ML16A-750-V-JET-D



TOP-Line 751R > 1.88

ML12	ML12	ML12
ML12A-750RC	-	-
ML16	ML16	ML16
ML16A-750RC	ML16A-750RC-D	ML16A-750RC-JET-D

MODU-LINE

Porte-plaquettes – Coupe déportée & contre-opération
 WSP-Halter – Versetztes Schneiden & Gegenspindel
 Insert holders – Cut off line & cut on subspindle

TOP-Line

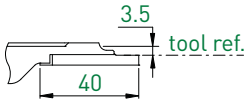

TOP-Line 751R > 1.88

Standard	-D	-JET-D
Art. N°	Art. N°	Art. N°
ML12	ML12	ML12
ML12A-750RC-R04	-	-
ML12A-750RC-SWISS-NANO	-	-

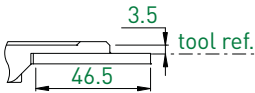

TOP-Line 771R > 1.137

ML12	ML12	ML12
ML12A-770RC-SWISS-NANO	-	-

Porte-plaquettes – Contre-opération
 WSP-Halter – Gegenspindel
 Insert holders – Cut on subspindle

TURN-Line

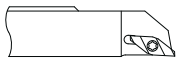

TURN-Line 337-339 > 6.12

Standard	-D	-JET-D
Art. N°	Art. N°	Art. N°
ML12	ML12	ML12
ML12A-330-V	ML12A-330-V-D	ML12A-330-V-JET-D
ML16	ML16	ML16
ML16A-330-V	ML16A-330-V-D	ML16A-330-V-JET-D

Porte-plaquettes – Contre-opération

WSP-Halter – Gegenspindel

Insert holders – Cut on subspindle

ISO-Line



ISO-Line
CC...0602..

> 7.16

Standard	-D	-JET-D
Art. N°	Art. N°	Art. N°
ML12	ML12	ML12
-	ML12A-SCLCL06-V-D	ML12A-SCLCL06-V-JET-D
ML16	ML16	ML16
-	ML16A-SCLCL06-V-D	ML16A-SCLCL06-V-JET-D

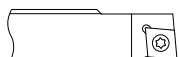

ISO-Line
CC...9T3..

> 7.16

ML12	ML12	ML12
-	ML12A-SCLCL09-V-D	ML12A-SCLCL09-V-JET-D
ML16	ML16	ML16
-	ML16A-SCLCL09-V-D	ML16A-SCLCL09-V-JET-D



ISO-Line
CC...0702..

> 7.16

ML12	ML12	ML12
-	ML12A-SDJCL07-V-D	ML12A-SDJCL07-V-JET-D
ML16	ML16	ML16
-	ML16A-SDJCL07-V-D	ML16A-SDJCL07-V-JET-D

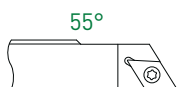

ISO-Line
DC...11T3..

> 7.30

ML12	ML12	ML12
ML12A-SDJCL11-V	ML12A-SDJCL11-V-D	ML12A-SDJCL11-V-JET-D
ML16	ML16	ML16
ML16A-SDJCL11-V	ML16A-SDJCL11-V-D	ML16A-SDJCL11-V-JET-D

MODU-LINE

Porte-plaquettes – Contre-opération

WSP-Halter – Gegenspindel

Insert holders – Cut on subspindle

ISO-Line

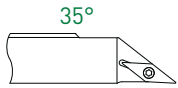

ISO-Line
VC...1103.. > 7.44

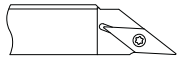

ISO-Line
VC...1303.. > 7.46

Standard	-D	-JET-D
Art. N°	Art. N°	Art. N°
ML12	ML12	ML12
ML12A-SVJCL11-V	ML12A-SVJCL11-V-D	ML12A-SVJCL11-V-JET-D
ML16	ML16	ML16
ML16A-SVJCL11-V	ML16A-SVJCL11-V-D	ML16A-SVJCL11-V-JET-D

ML12	ML12	ML12
-	ML12A-SVJCL13-V-D	-
ML16	ML16	ML16
-	ML16A-SVJCL13-V-D	ML16A-SVJCL13-V-JET-D

Porte-plaquettes – Coupe déportée

WSP-Halter – Versetztes Schneiden

Insert holders – Cut off line

EVO CUT-Line

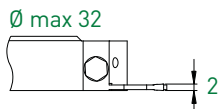

EVO CUT-Line
ET20 > 8.12

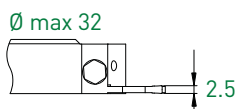

EVO CUT-Line
ET25 > 8.12

Art. N°	Art. N°	Art. N°
ML16	ML16	ML16
-	-	ML16A-ET20-V-JET-32

ML16	ML16	ML16
-	-	ML16A-ET25-V-JET-32

Porte-plaquettes – Coupe déportée

WSP-Halter – Versetztes Schneiden

Insert holders – Cut off line

EVOCUT-Line

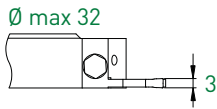

EVOCUT-Line
ET30 > 8.12

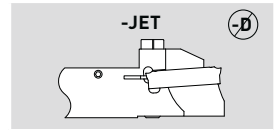

ML16	ML16	ML16
-	-	ML16A-ET30-V-JET-32

Porte-plaquettes – Coupe déportée

WSP-Halter – Versetztes Schneiden

Insert holders – Cut off line

CUT-Line

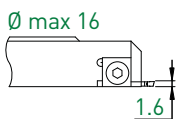

CUT-Line
CUT16 > 9.14

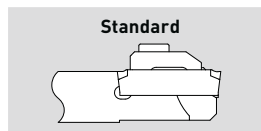

Art. N°	Art. N°	Art. N°
ML12	ML12	ML12
ML12A-CUT16-V	-	-
ML12F-CUT16-V	-	-
ML16	ML16	ML16
ML16A-CUT16-V	-	-
ML16F-CUT16-V	-	-

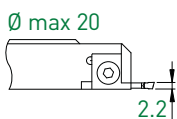

CUT-Line
CUT22 > 9.14

ML12	ML12	ML12
ML12A-CUT22-V	-	-
ML12F-CUT22-V	-	-
ML16	ML16	ML16
ML16A-CUT22-V	-	-
ML16F-CUT22-V	-	-

Porte-plaquettes – Coupe déportée & contre-opération

WSP-Halter – Versetztes Schneiden & Gegenspindel



Insert holders – Cut off line & cut on subspindle

PRO-Line

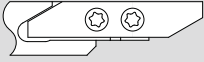

PRO-Line
632-636

> 3.08

Standard	-D	-JET-D
		
Art. N°	Art. N°	Art. N°
ML12	ML12	ML12
-	ML12A-630-V-D	ML12A-630-V-JET-D
ML16	ML16	ML16
-	ML16A-630-V-D	ML16A-630-V-JET-D

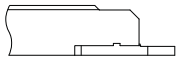

PRO-Line
651R

> 3.39

ML12	ML12	ML12
-	ML12A-650-V-D	ML12A-650-V-JET-D
ML16	ML16	ML16
-	ML16A-650-V-D	ML16A-650-V-JET-D

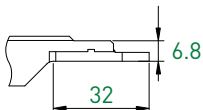

PRO-Line
651R

> 3.39

ML12	ML12	ML12
ML12A-650RC	ML12A-650RC-D	-
ML16	ML16	ML16
-	ML16A-650RC-D	ML16A-650RC-JET-D

Porte-plaquettes – Coupe déportée & contre-opération

WSP-Halter – Versetztes Schneiden & Gegenspindel



Insert holders – Cut off line & cut on subspindle

ECO-Line



ECO-Line
251-261

> 4.08

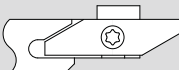
Standard	-D	-JET-D
		
Art. N°	Art. N°	Art. N°
ML12	ML12	ML12
ML12A-250-V	ML12A-250-V-D	ML12A-250-V-JET-D
ML16	ML16	ML16
ML16A-250-V	ML16A-250-V-D	ML16A-250-V-JET-D

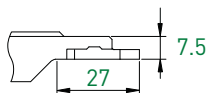

ECO-Line
251R

> 4.08

ML12	ML12	ML12
-	ML12A-250RC-D	-
ML16	ML16	ML16
-	ML16A-250RC-D	-

MODU-LINE

Modules d'arrosage
Kühlmittelzufuhrelemente
Coolant supply units

ML12 / ML16

ML12

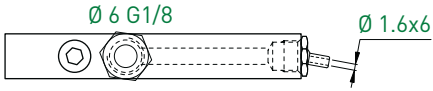

Raccord Anschluss Connection	Buses d'arrosage Kühlmitteldüse Coolant nozzles	ML12 Art. N°
Ø 6 G 1/8	5/16"	ML12-JET-5/16

ML16

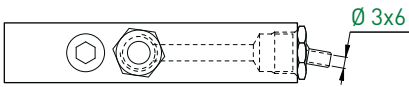

Raccord Anschluss Connection	Buses d'arrosage Kühlmitteldüse Coolant nozzles	ML16 Art. N°
Ø 6 G 1/8	7/16"	ML16-JET-7/16

buses optionnelles voir page 11.79
zusätzliche Düsen siehe Seite 11.79
optional nozzles see page 11.79

Modules de serrage
Spannelemente
Clamping units

ML12 / ML16

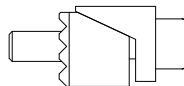
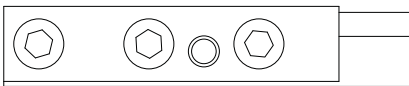

ML12 Art. N°	ML16 Art. N°
ML12-FIX-12/14	ML16-FIX-16/16
-	ML16-FIX-16/16.5
-	ML16-FIX-16/17
-	ML16-FIX-16/20
-	ML16-FIX-16/22
-	ML16-FIX-16/24

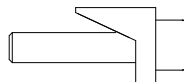
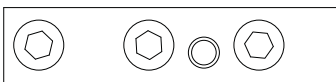

ML12 Art. N°	ML16 Art. N°
ML12-FIX-12	ML16-FIX-16

Buses d'arrosage

Kühlmitteldüsen

Coolant nozzles

5/16" / 7/16"

JET

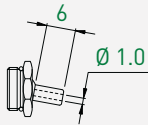
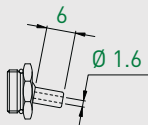
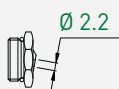
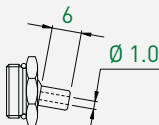
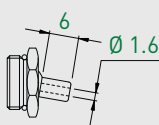
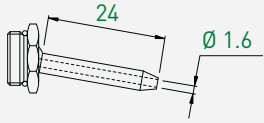
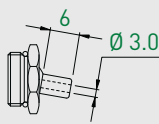
5/16"	Art. N°	Références compatibles Kompatible Artikeln Compatible items
	ML-JET 5/16-1.0x6	ML12-JET-5/1
	ML-JET 5/16-1.6x6	une buse ML-JET-5/16-1.6x6 est comprise eine Düse ML-JET-5/16-1.6x6 ist inbegriffen a nozzle ML-JET-5/16-1.6 x6 is included
	ML-JET 5/16-2.2x0	
7/16"	Art. N°	Références compatibles Kompatible Artikeln Compatible items
	ML-JET 7/16-1.0x6	
	ML-JET 7/16-1.6x6	ML16-KMX26-JET ML16-JET-7/16 ML12-DEC010-JET ML16-DEC013-JET ML16-DEC020-JET ML16-S20-JET ML16-SWISS-ST26-JET
	ML-JET-7/16-1.6x24	une buse ML-JET-7/16-3.0x6 est comprise avec chaque article ci-dessus eine Düse ML-JET 7/16-3.0x6 ist mit jedem vorstehenden Artikel inbegriffen
	ML-JET-7/16-3.0x6	a nozzle ML-JET 7/16-3.0x6 is included with each above item

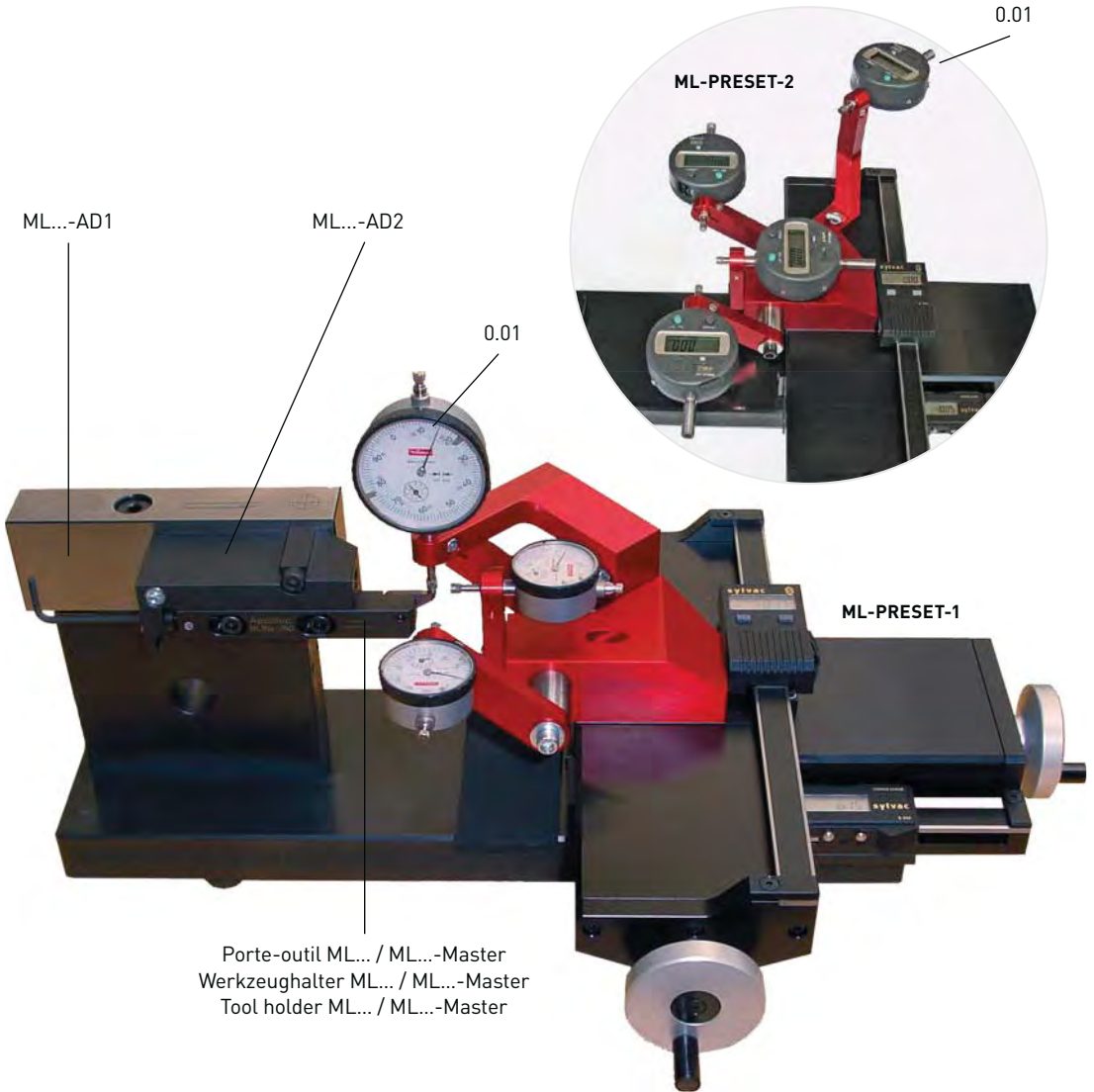

Art. N°

ML-PRESET-1

ML-PRESET-2

Banc de pré réglage

Voreinstellgerät

Presetting device

ML12 / ML16

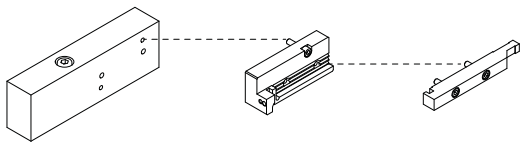
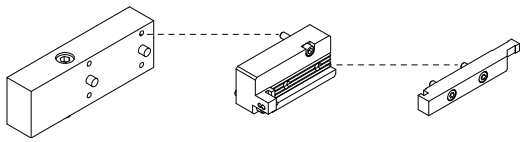
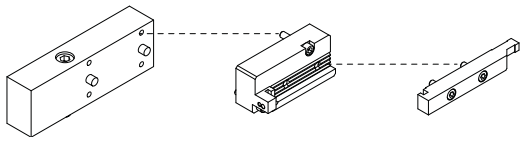
Type Typ Type	Machines Maschinen Machines	Adaptation Anpassungen Adapter	Adaptateurs et jauges d'étalonnage Adapter und Einstellehre Adaptators and master gauges
ML12	CITIZEN	C12/C16	 <p>ML12-AD1 ML12-AD2 ML12-MASTER</p>
		L12	
		R04	
		R07	
	HANWHA	XD20M	
	METAFIL	D10	
	STAR	SB12RG	
		SR10-J	
	TORNOS	SW12R11	
		DEC07/10 - EvoDEC0 10	
		SWISS-NANO	
		SWISS-NANO 7	
		DT13	
		CT20	
TSUGAMI	GT13		
	B074		
	B075		
	P034		
ML16	CITIZEN	K16	 <p>ML16/20-AD1 ML16-AD2 ML16-MASTER</p>
		L20	
		L20E	
	HANWHA	SL12/16	
	MANUHRIN	KMX 426/526/626	
		SA-12/SA16/SA16R	
	STAR	SB16	
		SB16/20RG	
		SB20	
		SR20J	
		SR20R	
		SR20R111	
		SR20R1V	
		SR32J	
		SV12/20	
		SW20R	
	TORNOS	DEC020/26 - EvoDEC020/32	
		SIGMA20/32	
		DT26	
GT26			
GT32			
ML16	TORNOS	DEC013- EvoDEC016	 <p>ML16-DEC013-AD1 ML16-DEC013-AD2 ML16-MASTER</p>
	ST26		

ML12

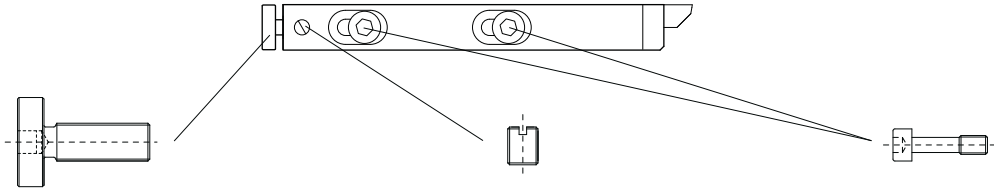

Vis de réglage
 Einstellungsschraube
 Setting screw

Art. N°

ML12A-M5X0.5

Vis de blocage
 Blockierschraube
 Locking screw

Art. N°

ML-M4X4-T

Vis de fixation
 Befestigungsschraube
 Fixing screw

Art. N°

ML12-M5XL20

ML16

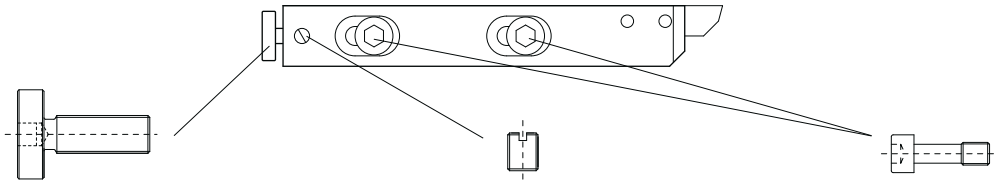

Vis de réglage
 Einstellungsschraube
 Setting screw

Art. N°

ML16A-M5X0.5

Vis de blocage
 Blockierschraube
 Locking screw

Art. N°

ML-M4X4-T

Vis de fixation
 Befestigungsschraube
 Fixing screw

Art. N°

ML16/20-M6XL20

Art. N°

ML-205004



Butée à ressort
 Federnde Schraube
 Spring bumper

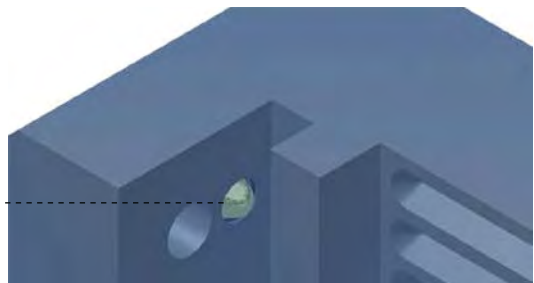



Pièces de rechange

Ersatzteile

Spare parts

ML12 / ML16

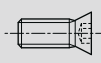
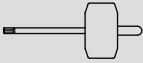
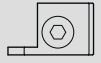
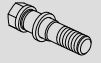
Vis et clés pour le serrage des plaquettes
Schrauben und Schlüssel für WSP-Befestigung
Screws and keys for insert clamping

Porte-outils Halter Holders					
ML...250	V-M4X9-T15	C-T15	-	-	-
ML...260	V-M2.5X7.8-T8	C-T8	-	-	-
ML...330	V-M2.5X7.8-T8	C-T8	-	-	-
ML...340	V-M2.5X7.8-T8	C-T8	-	-	-
ML...630	V-M4X9-T15	C-T15	-	-	-
ML...640	V-M4X9-T15	C-T15	-	-	-
ML...650	V-M4X9-T15	C-T15	-	-	-
ML...650RC	V-M4X6.5-T15	C-T15	-	-	-
ML...660	V-M4X9-T15	C-T15	-	-	-
ML...730	V-M3X7-T8	C-T8	-	-	-
ML...730RC	V-M3X5.5-T8	C-T8	-	-	-
ML...730RC-R04	V-M3X4.5-T8 V-M3X7-T8	C-T8	-	-	-
ML...730RC-SWISS-NANO	V-M3X4.5-T8 V-M3X7-T8	C-T8	-	-	-
ML...740	V-M3X7-T8	C-T8	-	-	-
ML...750	V-M4X9-T15	C-T15	-	-	-
ML...750RC	V-M4X7.3-T15	C-T15	-	-	-
ML...750RC-R04	V-M4X5.6-T15 V-M4X7.3-T15	C-T15	-	-	-
ML...750RC-SWISS-NANO	V-M4X5.6-T15 V-M4X7.3-T15	C-T15	-	-	-
ML...760	V-M4X9-T15	C-T15	-	-	-
ML...770RC-SWISS-NANO	V-M4X7.3-T15	C-T15	-	-	-
ML...780	V-M4X9-T15	C-T15	-	-	-
ML...SC...06	V-M2.5X5.8-T8	C-T8	-	-	-
ML...SC...09	V-M4X7-T15-ISO	C-T15	-	-	-
ML...-SD...07	V-M2.5X7.8-T8	C-T8	-	-	-
ML...-SD...07-D	V-M2.5X5.8-T8	C-T8	-	-	-
ML12...-SDJ...11	V-M4X7-T15-ISO	C-T15	-	-	-
ML12...-SDN...11	V-M4X9-T15-ISO	C-T15	-	-	-
ML16...-SD...11	V-M4X9-T15-ISO	C-T15	-	-	-
ML...-SV...11	V-M2.5X7.8-T8	C-T8	-	-	-
ML...-SV...13	V-M3X7.3-T8-ISO	C-T8	-	-	-
ML...-CUT16	-	-	CUT16RS-SET	-	-
ML...-CUT16-V	-	-	CUT16LS-SET	-	-
ML...-CUT22	-	-	CUT22RS-SET	-	-
ML...-CUT16-V	-	-	CUT22LS-SET	-	-
ML16...-ET... JET32	-	-	-	V-M5X21-6P7-J	C-6PEX-7.0
ML16...-ET... V-JET32	-	-	-	V-M5X21-6P7-J	C-6PEX-7.0